



PROCÉDÉS CHÉNEL[®] INTL.
Architectures de papiers

2024

CATALOGUE GÉNÉRAL
GENERAL CATALOGUE



CATALOGUE GÉNÉRAL

GENERAL CATALOGUE

Photo : ©Alexandra Masbout



PROCÉDÉS CHÉNEL[®] INTL

Architectures de papiers

PROCÉDÉS CHÉNEL INTERNATIONAL est une équipe pluridisciplinaire qui bénéficie de racines professionnelles profondes plus que centenaires. Elle est spécialisée dans la création, le développement et la distribution de matériels et techniques destinés aux concepteurs d'expositions, de l'événementiel et de l'architecture intérieure.

Engagée depuis de nombreuses années dans un processus d'amélioration constante, tant au niveau sociétal qu'environnemental, PROCÉDÉS CHÉNEL INTERNATIONAL est à même de vous offrir des solutions plus responsables pour vos projets.

PROCÉDÉS CHÉNEL INTERNATIONAL: a pluridisciplinary, creative and dynamic team helping designers since 1896 with worldwide development, production and distribution of decorative solutions technologies and materials. Our inspirational range of products is ideal for creative designers to conceive trade or domestic exhibition stands, events, interior architecture...

Committed for years in an always improving process on societal as well as environmental levels, PROCÉDÉS CHÉNEL INTERNATIONAL is able to offer you more responsible solutions for your projects.

70, rue Jean Bleuzen - 92170 Vanves - France
T : +33 (0)1 41 08 76 76 - F : +33 (0)1 41 08 01 53
info@chenel.com - www.chenel.com



IMPRIM'VERT[®]

unimev[®]

IPES



LES ENGAGEMENTS RESPONSABLES DE PCI

PCI'S RESPONSIBLE COMMITMENTS

FABRICATION D'OBJETS (MOBILIER, STAND...)
en collaboration avec des créateurs

OBJECTS MANUFACTURING (FURNITURE, STAND...)
in collaboration with creative professionals



RÉUTILISATION
RE-USE

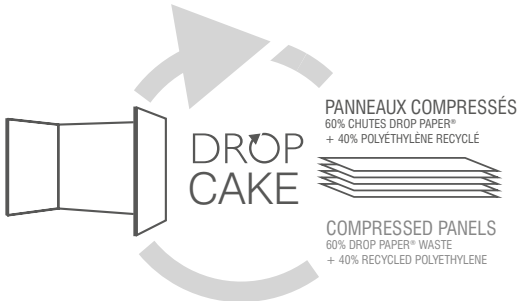
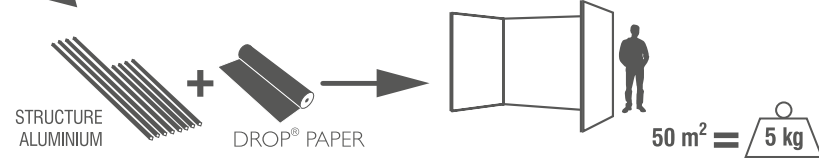

1 LÉGÈRETÉ DES MATIÈRES (moins de consommation matières, transport et montage facilités)

LIGHT MATERIALS (Less matter consumption, easier transportation and putting up)

5 RECYCLAGE DU DROP PAPER®
DROP PAPER® RECYCLING

PROCÉDÉS CHÉNEL® INTL.
Architectures de papiers

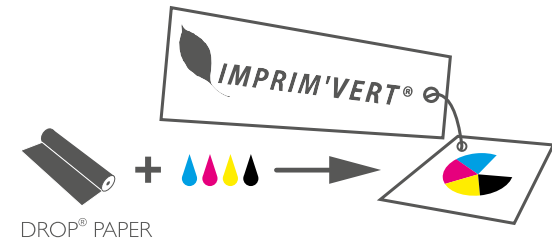

2 IMPRESSIONS CERTIFIÉES IMPRIM'VERT®
CERTIFIED 'IMPRIM'VERT' PRINTINGS



4 ENGAGEMENT CARITATIF & MISSIONS PÉDAGOGIQUES
CHARITY COMMITMENT & EDUCATIONAL MISSIONS

3 COLLABORATION AVEC DES ATELIERS DE RÉINSERTION
COLLABORATION WITH REHABILITATION WORKSHOPS

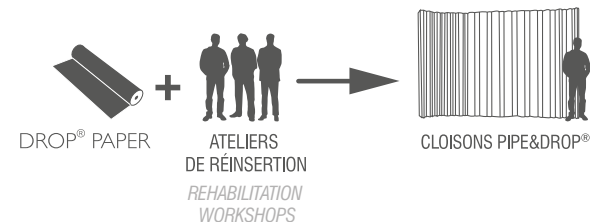

ÉCOLES DE DESIGN
DESIGN SCHOOLS

ACCÈS LOCAUX
ACCÈS MATIÈRE
ORGANISATION DE CONCOURS
ACCESS TO PROCÉDÉS CHÉNEL'S FACILITIES
ACCESS TO PROCÉDÉS CHÉNEL'S MATERIALS
COMPETITIONS



PICTOS

KEYS



Description
Description



Résistance au feu
Fire resistance

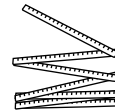

Dimensions
Dimensions



Utilisation
Examples of use



Impression
Printing



Modes de fixation
Fixing methods



Stockage
Storage



Particularités
Specifics



Durabilité
Durability



LES MATÉRIAUX

THE MATERIALS



D R O P P A P E R
D R O P[®]
 D R O P S C R E E N

Best Booth Award for IBERIA at FITUR / International Tourism Fair in Madrid 2020
 Made by Maxiart & Jesus San Vicente (architect)

D R O P P A P E R
D R O P[®]
 D R O P S C R E E N



Non-tissé composé de cellulose, polyester et fibre de verre.
 Aspect fibreux.

*Non-woven made of cellulose, polyester and fiber glass.
 Fibrous aspect.*



Classé non feu M1, Euroclass Bs1d0, NFPA 701.

Fire resistant M1, Euroclass Bs1d0, NFPA 701.



Intérieur.
 Architecture pérenne et temporaire, plafonds, cloisons, bannières,
 kakémonos, luminaires, origami...

*Indoor.
 Temporary and long-lasting architecture, ceilings, partition walls,
 banners, lamp shades, origamis...*

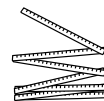

60gr.
 Laize : 2,40 m maximum (et toute autre laize inférieure).
 Rouleaux de 25 ml ou 50 ml et plus

*60gr.
 2,40 m wide maximum and any inferior width.
 Rolls of 25 lm or 50 lm and more.*



Imprimable par sublimation, encres latex et UV.

Printable with dye sublimation, latex and UV inks.



Existe en 15 couleurs.
 Légèreté exceptionnelle (60gr/m²), luminescent et diffuseur de lumière.
 Facile à découper et à confectionner, très stable dimensionnellement, conserve
 la mémoire de plis.
Recyclable en Drop[®] Cake par Procédés Chénel.

*Available in 15 colours.
 Exceptional lightness (60gr/sqm), good light diffuser
 with luminescent appearance.
 Easy to cut and to transform, good dimensional stability, keeps memory
 of folds.
 Recyclable into Drop[®] Cake by Procédés Chénel.*



D R O P P A P E R
D R O P[®]
 D R O P S C R E E N

Toi & Moi McArthurGlen, Athens
 Design : Adrianopoulos + Associates

Couleurs non contractuelles.
 N'hésitez pas à nous demander des échantillons.

*Non-contractual colors.
 Do not hesitate to ask us for color samples.*

	100 Blanc <i>100 White</i>
	101 Beige clair <i>101 Light tan</i>
	117 Jaune <i>117 Yellow</i>
	308 Orange <i>308 Orange</i>
	122 Rouge <i>122 Red</i>
	315 Fuchsia <i>315 Fuchsia</i>
	320 Prune <i>320 Plum</i>
	111 Bleu foncé <i>111 Dark blue</i>
	360 Bleu Céladon <i>360 Celadon Blue</i>
	133 Bleu lavande <i>130 Lavender</i>
	304 Vert anis <i>304 Anis green</i>
	C112 Bourgeon * <i>C112 Bud *</i>
	C115 Vert * <i>C115 Green *</i>
	C19 Perroquet * <i>C19 Parrot *</i>
	C85 Menthe * <i>C85 Mint *</i>
	C96 Gazon * <i>C96 Grass *</i>
	C90 Pré * <i>C90 Meadow *</i>
	350 Dune <i>350 Dune</i>
	103 Gris clair <i>103 Light grey</i>
	104 Gris foncé <i>104 Dark grey</i>
	144 Noir <i>144 Black</i>



Le Fluo Drop® est une gamme de Drop Paper® de trois couleurs fluorescentes.

The Fluo Drop® is part of the Drop Paper® collection, available in three fluorescent colours.



Classé non feu M1.

Fire resistant M1.



Intérieur.
Architecture temporaire, kakemono, cloison, bannière, luminaire, faux plafond...

*Indoor.
Temporary architecture, kakemono, partition, banner, lamp shade, ceiling...*

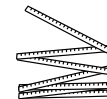

Drop Paper® 60gr/m².
1,80 m de laize.
Rouleaux de 25ml ou 50 ml.

*Drop Paper® 60gr/m².
1.80 m wide / 70.86"
Rolls of 25 lm or 50 lm.*



Risque d'affaiblissement de la couleur si exposée à la lumière de longues périodes de temps.

Recyclable en Drop® Cake par Procédés Chénel.

*Color may fade if exposed too long under light.
Recyclable into Drop® Cake by Procédés Chénel.*



Modiefabriek, Amsterdam

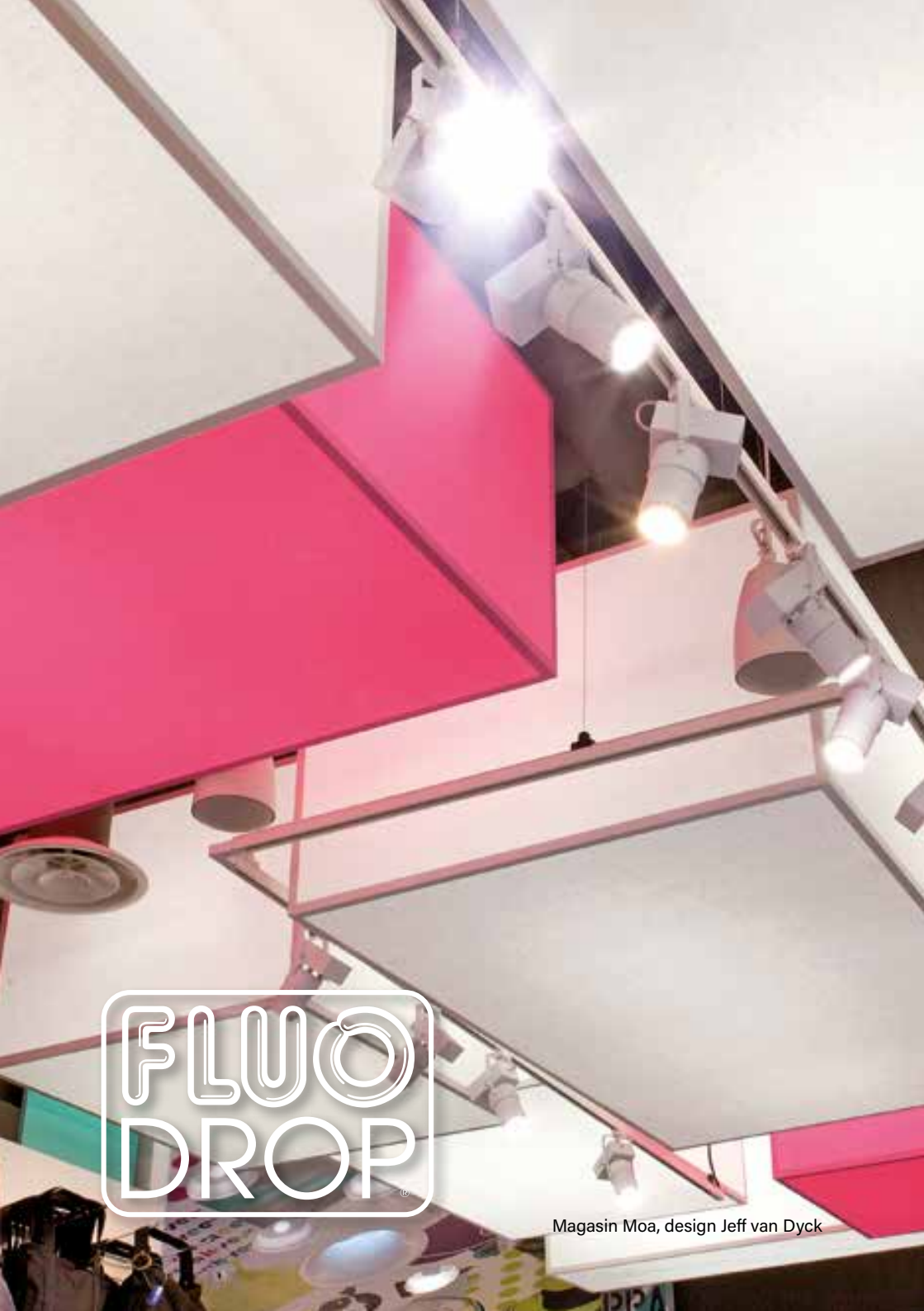

FLUO
DROP

Magasin Moa, design Jeff van Dyck

Couleurs non contractuelles.
N'hésitez pas à nous demander des échantillons.

*Non-contractual colors.
Do not hesitate to ask us for color samples.*

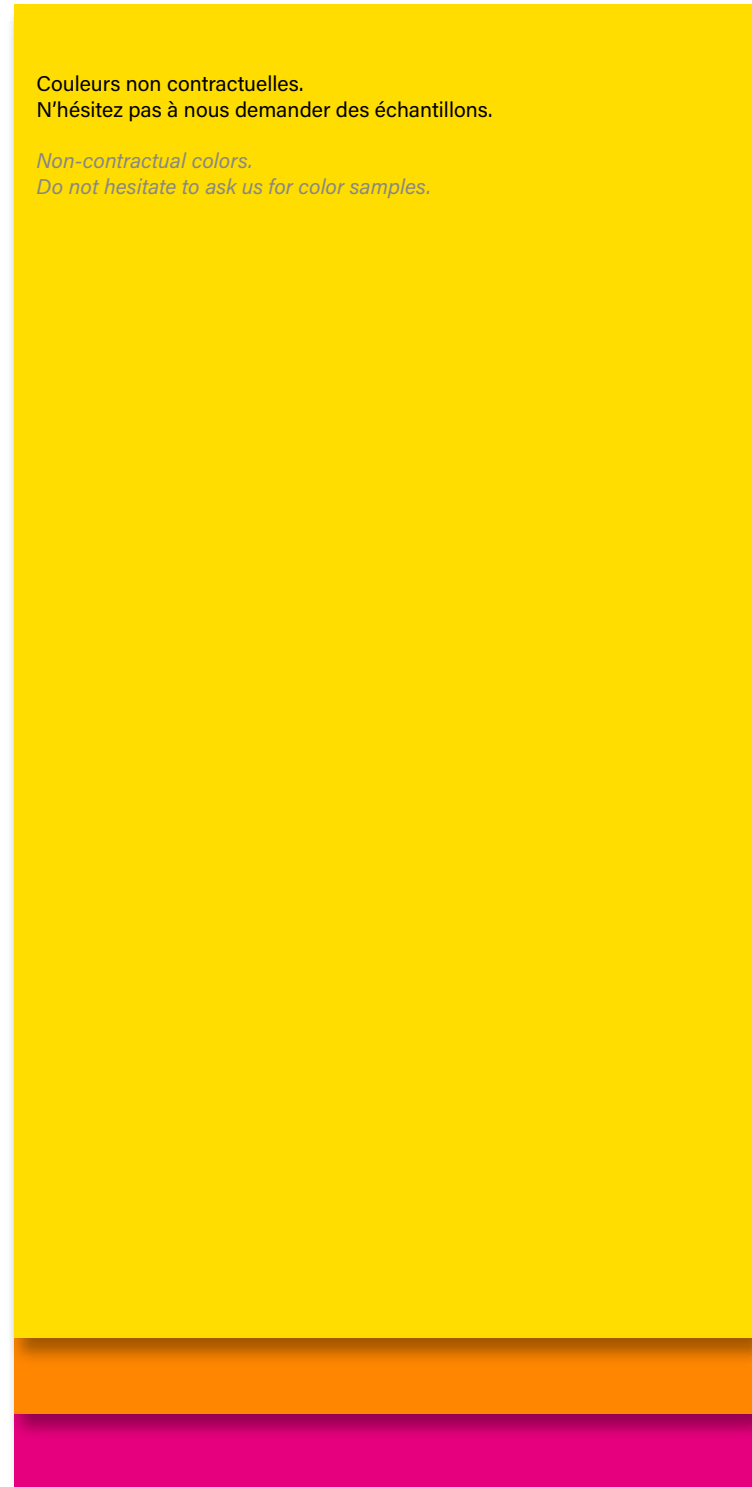

900 Jaune
900 Yellow

901 Orange
901 Orange

902 Magenta
902 Magenta



alacarte

100 colors
Design Emmanuelle Moureaux

alacarte



Non-tissé composé de cellulose, polyester et fibre de verre.
Aspect fibreux.

*Non-woven made of cellulosis, polyester and fiber glass.
Fibrous aspect.*



Classé non feu M1.

Fire resistant M.



Intérieur.
Architecture temporaire, kakemono, cloison, bannière, luminaire,
faux plafond...

*Indoor.
Temporary architecture, kakemono, partition, banner, lamp shade, ceiling...*

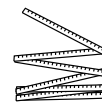

60gr.
Laize : 1,57 m.

*60 gr.
1,57 m wide (61").*



Imprimable par sublimation, encres latex et UV.

Printable with dye sublimation, latex and UV inks.



40 couleurs. Minimum de commande 25 ml. Délai de 3 semaines.
Exception sur les couleurs marquées d'une *, toujours disponibles et sans
minimum de commande.

Recyclable en Drop® Cake par Procédés Chénel.

*40 colours. Minimum order 25 lm. 3 weeks delivery time.
Exception for the colors spotted by a *, always on stock and without a
minimum order.*

Recyclable into Drop® Cake by Procédés Chénel.

Couleurs non contractuelles.
N'hésitez pas à nous demander des échantillons.

*Non-contractual colors.
Do not hesitate to ask us for color samples.*

ARGENT	
MAGNOLIA	
PÊCHE	
FIGUE	
ALTHEA	
NOCTURNE	
MÉDITERRANÉE	
PERVENCHE	
CYAN	
LAGON	
MYOSOTIS	
JADE	
MÉLÈZE	
CYPRÈS	
GAZON*	
VERT*	
PERROQUET*	
BOURGEON*	
MENTHE*	
PRÉ*	

Couleurs non contractuelles.
N'hésitez pas à nous demander des échantillons.

*Non-contractual colors.
Do not hesitate to ask us for color samples.*

	CAFÉ
	TABAC
	SEIGLE
	LIERRE
	SERIN
	OR ANCIEN
	ORANGE
	ÉCUREUIL
	SAUMON
	FEU
	ROUGE FONCÉ
	CORAIL
	BORDEAUX
	CHAUDRON
	PASTÈQUE
	MOUSSERON
	AMANDIER
	TENDRESSE
	IRIS
	LILAS



Pulp DROP



Pulp DROP



Un papier 100% cellulose, certifié FSC.

A 100% cellulose paper, FSC certified.



Classé non feu M1, B1, Class 1, NFPA 701.

Fire resistant M1, B1, Class 1, NFPA 701.



Intérieur.
Architecture temporaire, kakemono, cloison, bannière, luminaire,
faux plafond...

Indoor.

Temporary architecture, kakemono, partition, banner, lamp shade, ceiling...

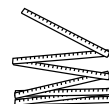

Laize : 1,27 m.
Rouleaux de 60m.
150 gr

*1,27 m wide (50").
60 ml rolls.
150 gr*



Imprimable par sublimation, encres latex.

Printable with dye sublimation, latex inks.



PERFO DROP®



Drop Paper® perforé, blanc ou noir.

White or black perforated Drop Paper®



Classé non feu M1.

Fire resistant M1.



Intérieur. Architecture temporaire, kakemono, cloisons, bannière, luminaire, faux plafond...

Indoor. Temporary architecture, kakemono, partitions, banners, lamp shades, ceilings...

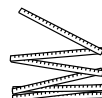

60 gr.
Laize : 1,60 m

60 gr.
Width: 1,60 m

PERFO DROP®

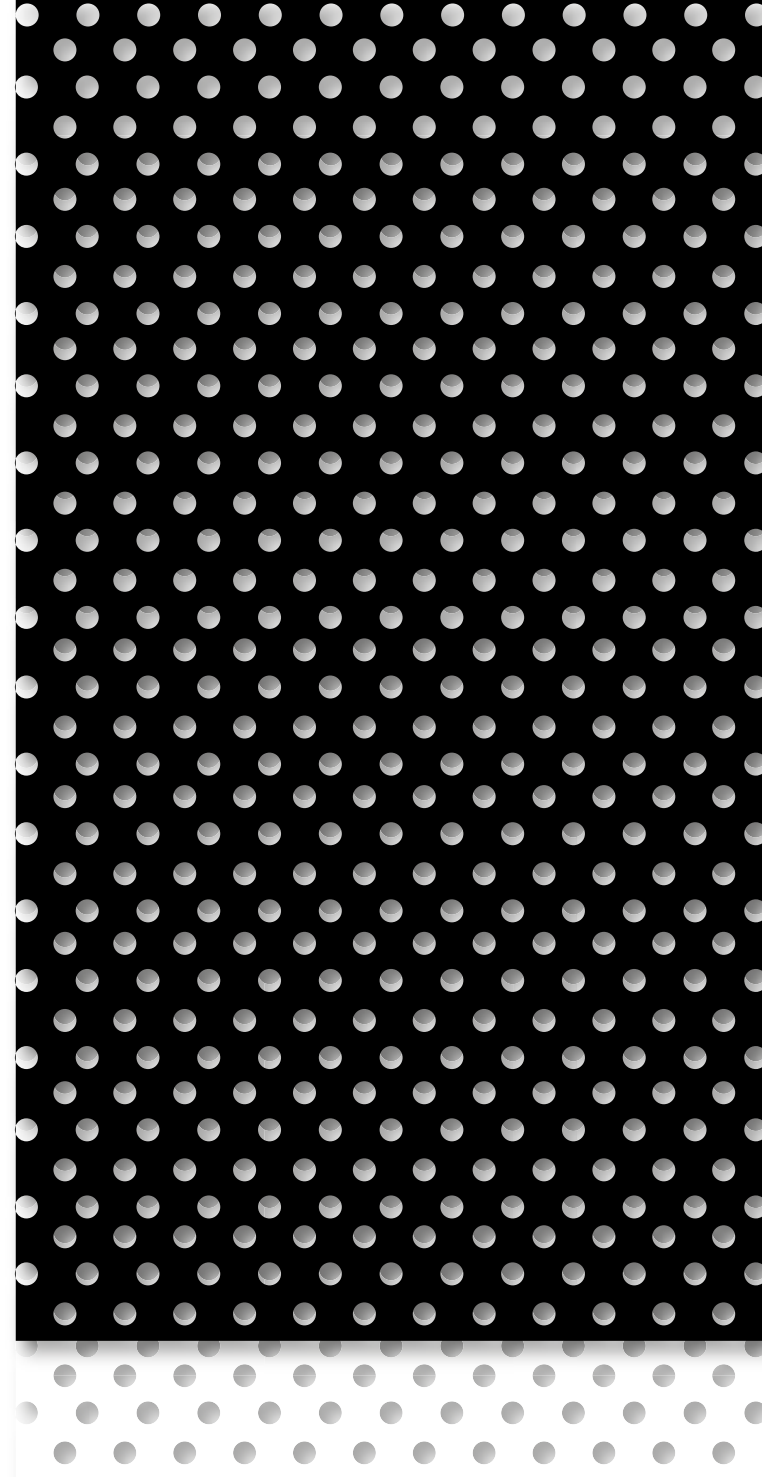



DROPJET®

Printed Drop Paper / Exhibition « Bordeaux Ville de Pierre, un patrimoine à vivre ! »
Maison du Projet des Bassins à Flot

DROPJET®

88 gr. & 138 gr.

88 gr. Non-tissé composé de cellulose, polyester et fibre de verre.
Aspect fibreux. Spécialement conçu pour l'impression jet d'encre.

*88 gr. Non-woven made of cellulose, polyester and fiber glass.
Fibrous aspect. Especially designed for inkjet printing.*



138 gr. Non tissé composé de cellulose et polyester, sans fibre de verre.
Aspect lisse. Spécialement conçu pour l'impression jet d'encre.

*138 gr. Non-woven made of cellulose and polyester, without fiber glass.
Smooth texture. Especially designed for inkjet printing.*



Classé non feu M1.

Fire resistant M1.



Intérieur. Architecture temporaire, kakemono, cloisons, bannière,
luminaire, faux plafond...

*Indoor. Temporary architecture, kakemono, partitions, banners,
lamp shades, ceilings...*

88gr. : Épaisseur 0,22 mm. Ø mandrin : 76 mm.
Longueur : 50ml. Laize : 1,27 m - 1,524 - 2,40 m.

*88gr.: Thickness 0.22 mm. Ø core: 76 mm. Length: 50 lm.
Width: 1,27m / 50" - 1,52m / 60" - 2,40m / 94"*

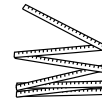

138 gr. : Épaisseur 0,22 mm. Ø mandrin : 76 mm.
Longueur : 25 ml. Laize : 1,27 m - 1,524 - 2,40 m.

*138 gr.: Thickness 0.22 mm. Ø core: 76 mm.
Length: 25 lm. Width: 1,27m / 50" - 1,52m / 60" - 2,40m / 94"*



88gr. : eco solvant, solvant, UV and latex.
138 gr. : UV.

*88gr.: eco solvent, solvent, uv and latex.
138 gr.: UV.*



Plusieurs possibilités de fixations *
Adhésif double face 3M 950 (ourlets).
Velcro (Lighted Drop®).
Adhésif repositionnable (Luminaire).



*Many fixing methods *
Double sided adhesive tape 3M 950 (hem pockets).
Velcro (Lighted Drop®).
Removable adhesive tape (Lightings).*

Après utilisation, doit être rangé soigneusement dans son emballage d'origine à l'abri de l'humidité et verticalement pour une conservation optimale.

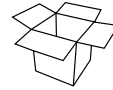

After usage, carefully place the roll vertically in the original packaging without humidity for the best conservation.

Très bonne stabilité dimensionnelle.
138 gr. : stabilité dimensionnelle inférieure au 88 gr.
138 gr. : diffusion de la lumière inférieure au 88 gr.
Impression recto seul.
Produit léger.
Bonne diffusion de la lumière.
Réutilisation difficile.
Ne résiste pas à l'eau.
Faible résistance mécanique.



*No curving effect.
138 gr.: dimensional stability inferior to 88 gr.
138 gr.: light diffusion inferior to 88 gr.
One side printing only.
Lightweight product.
Good light diffusion.
Difficult to re-use.
Not water resistant.
Delicate material.*

Dépend de l'application : un luminaire suspendu ou un plafond installés dans un lieu propre et sec peuvent durer plus de 5 ans..



Depending on the application: a hung lighting element or a ceiling installed in a dry and clean place can last more than 5 years.

Note : Ces informations correspondent à nos connaissances actuelles et sont destinées à vous informer, sans obligation, sur nos produits et leurs usages.

Nota: This information corresponds to our present state of knowledge and is meant to inform you without obligation about our products and their use.

DROPEX®



easy DROP®



Papier peint pré-encollé.

Pre-coated with adhesif wallpaper.



Euro Class : Bs1d0.

Euro Class : Bs1d0.



Intérieur.
Décoration murale.

*Indoor.
Décoration mural.*

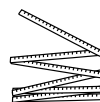

167gr
Laize : 1,20 m

*167gr
1,20m/47" wide*



Imprimable par encres latex et UV.

Printable with latex and UV inks.



Rouleaux de 25 ml.
Peut être découpé sur mesure.
Ne nécessite qu'un spray d'eau pour être installé sur un mur.
Se retire facilement

*25 ml rolls
Can be cut upon order
Ony needs water sprayed to stick on a wall
Can be easily peeled off*

easy DROP®

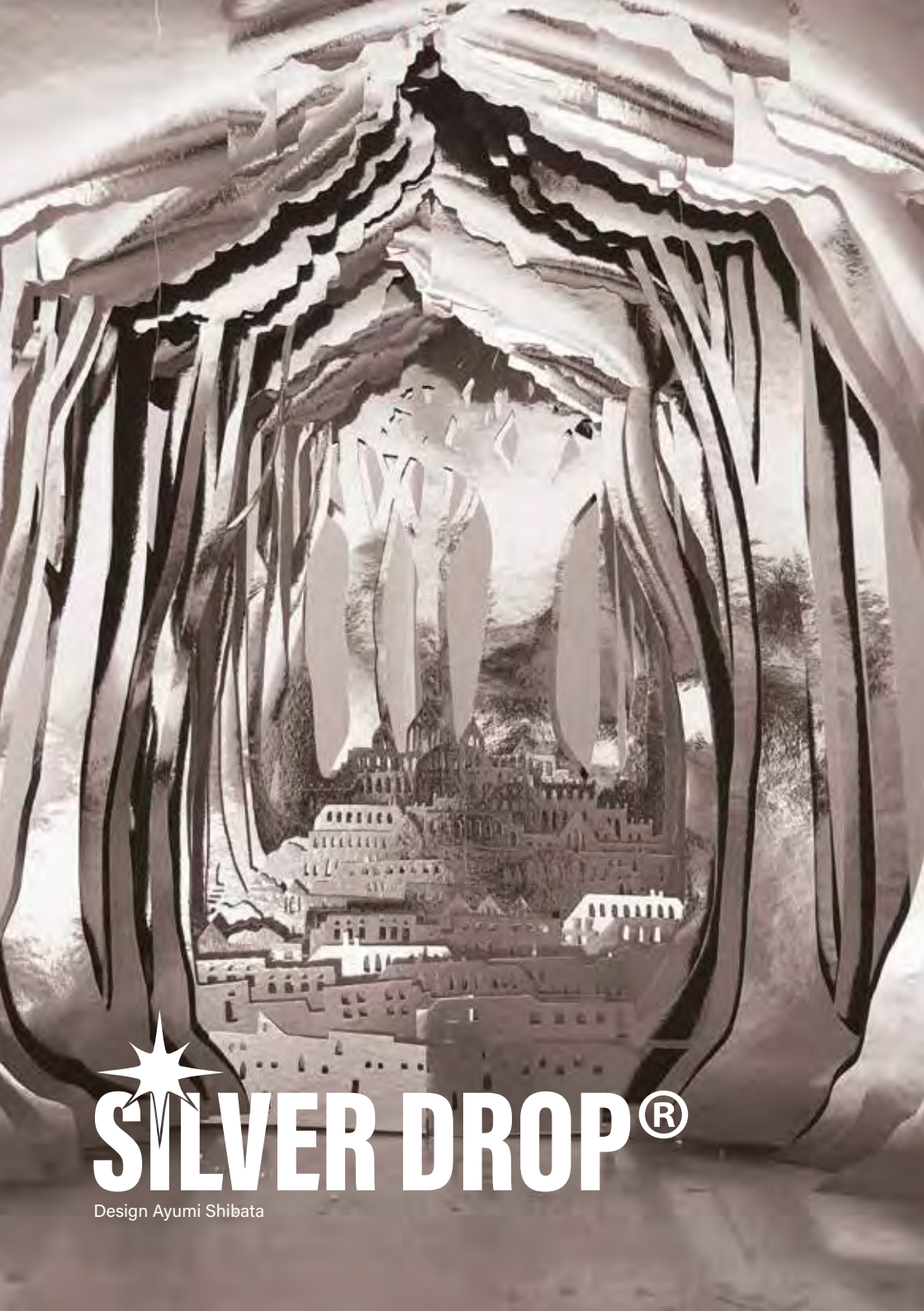

SILVER DROP®

Design Ayumi Shibata

SILVER DROP®

Le Silver Drop® est une technique permettant l'ajout d'une fine couche d'aluminium sur Drop Paper® blanc 60 gr. Cette option apporte au Drop Paper® un aspect miroir argenté.



Silver Drop® is a technique that adds a thin layer of aluminium onto a 60gr white Drop Paper®. Silver Drop® creates a shiny mirror effect on Drop Paper®.



Classé non feu M1, Euroclass : Bs3d0, B1.

Fire resistant M1, Euroclass: Bs3d0, B1.

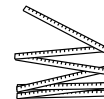

130 gr/m².
Laize : 0,95 m.

*130 gr/m².
width: 0,95m / 37.4"*



Faux plafond, luminaire, bannière et displays etc...

Ceilings, lightings, banners and displays...



Impression numérique à base aqueuse, encres latex et UV.

Digital printing : dye, latex and UV inks.



Résistance mécanique.

Opacité 90 %.

100 % recyclable.

Pâte naturelle issue de la gestion durable des forêts.

Mechanical strength.

90% opaque.

100% recyclable.

Natural paste from sustainable forest management.



GOLDEN DROP®

Silver Drop printed copper and laser cut / Trends area / Hotel & Lodge

GOLDEN DROP®

Le Golden Drop® est une technique permettant la métallisation sur Drop Paper et Drop Jet. Cette option apporte au Drop® Paper un aspect scintillant par transfert de feuilles dorées selon un motif à définir parmi un catalogue disponible.



Golden Drop® is a technique where a metal finish is applied onto Drop Paper and Drop Jet. Golden Drop® offers a shiny golden effect to the Drop, thanks to the transfer of gold sheets with a pattern to choose from our catalogue.



Classé non feu M1, Euroclass : Bs3d0, B1.

Fire resistant M1, Euroclass: Bs3d0, B1.

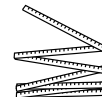

Laize : 0,95 m.

width: 0,95m / 37.4"



Support haut de gamme, le Golden Drop® donne un aspect brillant aux applications qui en sont faites. Il répond plus particulièrement aux utilisations du secteur du luxe pour une signalétique ou un décor des plus étincelants.

Golden Drop® is a «top of the range» material that has a shiny touch to the surface. Especially manufactured for the luxury sector and used for signage or interior displays requiring flashy and classy renderings.



Existe en or ou argent, autres couleurs sur demande.
Imprimable si la métallisation s'applique sur Drop Jet.

*Available in gold and silver, other colors on demand.
Printable if metal finish is applied onto Drop Jet.*



CRISTAL
DROP®

CRISTAL
DROP®

Première Vision, Design by Vachon



Papier calque translucide en cellulose, classé non feu et imprimable, pour la réalisation de luminaires, bannières, displays etc...

Tracing paper, translucent and made of cellulosis, fire resistant and printable to create lightings, banners, displays etc...



Classé non feu M1.

Fire resistant M1.

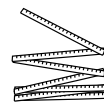

125 gr/m².
Laize : 1,27 m.

*125 gr/m².
width: 1,27 m / 50"*



Impression numérique à base aqueuse, encres latex et UV.

Digital printing dye, latex and UV inks.



Opacité 20 %.
100 % végétal.
100 % recyclable.
Pâte naturelle issue de la gestion durable des forêts.

*Opacity: 20 %.
100 % vegetal.
100 % recyclable.
Natural paste from sustainable forest management.*

SILK DROP®



Papier de soie, 100 % cellulose, 25 gr/m²

Silk paper 100 % cellulosis, 25 gr/m²



Classé non feu M1.

Fire resistant M1.



Intérieur, décors par pliage et froissage, origami.

Indoor, displays by folding or creasing smoothly, origami

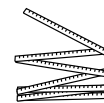

Laize : 1 m

Rouleaux de 250 ml

Width : 1m / 39.37"

Rolls of 250 ml



Existe en blanc.

Luminescent et diffuseur de lumière.

légèreté exceptionnelle (25 gr/m²).

Sensible aux variations thermiques et hygrométriques.

Available in white.

Good light diffuser with luminescent appearance.

Exceptional lightness (25gr/m²).

Sensitive to thermal and moisture.

SILK DROP®

Défilé STONE ISLAND 30
Design MATTIA DORICI & LUCA BERTOZZI



KRAFT DROP®



Papier kraft pure cellulose.

Pure cellulose kraft paper.



Classé non feu M1.

Fire resistant M1.

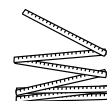

146 gr/m².
Laize : 1 m.

*146 gr/m².
width: 1m / 39.37"*



Faux plafond, luminaire, bannière et displays etc...

Ceilings, lightings, banners and displays...



Impression numérique à base acqueuse, encres latex et UV.

Digital printing : dye, latex and UV inks.



Résistance mécanique.

Opacité 90 %.
100 % recyclable.

Pâte naturelle issue de la gestion durable des forêts.

Mechanical strength.

90% opaque.

100% recyclable.

Natural paste from sustainable forest management.

KRAFT DROP®



Lejaby



DROPNET®

Manor, Design Saguez & Partner

DROPNET®



Le Drop Net® est un textile semi transparent léger, composé à 100 % de polyester. Ce support est imprimable et permet une lisibilité de l'impression recto verso. La légèreté de la matière apporte un côté subtil et esthétique à son utilisation.

Drop Net® is a 100% polyester semi-transparent knitted mesh textile, to achieve light and subtle interior screens. This printable solution is visible on both sides.



Classé non feu M1.

Fire retardant M1.

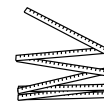

180 gr/m².
Laize : 1,80 m.

*180 gr/m².
width: 1,80m / 70.86"*



Idéal pour des écrans imprimés suspendus ou marouflés sur cadre. Il est très apprécié pour mettre en valeur la signalétique ou pour jouer avec les séparations d'espaces dans les salons, expositions.

Ideal for printed screens, suspended or framed. Signage, partition walls within trade fairs and exhibitions...



Compatible avec tout type d'imprimante, encres latex et UV.

Compatible with any digital printers, latex and UV inks.

PROCÉDÉS CHÉNEL®
INTERNATIONAL
Matériaux et Techniques spécialisés pour l'Exposition, la Décoration et la Muséographie.

STRONG
DROP®

Paper Night 2010, Procédés Chénel

STRONG DROP®



Non tissé blanc très résistant, 70% polyester et 30% polyamide.

Very resistant white non woven, 70% polyester and 30% polyamide.



Classé non feu M1.

Fire resistant M1.

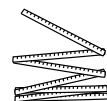

120 gr/m².
Laize : 2,20 m.

120 gr/m².
width: 2,20m / 86,6"



Réalisation de volume lumineux, guirlandes, bannières, etc.

For lightings, garlands, banners, etc.



Imprimable dye et solvant, encres latex et UV.

Printed with dye or solvent, latex and UV inks.



Forte résistance mécanique.
Fabrication propre.
Sans PVC.
Composants inoffensifs.
Déchets sans risques.
Labélisé Oeko-Tex 100 classe 1.

*High mechanical resistance.
Clean production.
PVC free.
Innocuous substances.
Safe wastages.
Labelised Oeko-Tex 100 class 1.*

HEMP DROP®

Sasha Nordmeyer

HEMP DROP®

Papier de qualité Fine Art, à base de chanvre et de linters de coton (fibres fines secondaires qui entourent la graine du cotonnier, non utilisables par l'industrie textile).



Fine Art quality paper, made from hemp and cotton linters (fine secondary fibers which surround the seed of the cotton plant, not usable by the textile industry).



Classé non feu M1.

Fire resistant M1.



Idéal pour réaliser des origamis géants.

Ideal for large origamis.

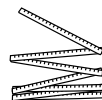

Rouleau de 50 ml, 1,20 m de laize
280 gr /m²

*Rolls of 50 ml, 1.20 ml wide.
280 gr /m²*



Impression numérique à base aqueuse, encres latex et UV.

Digital printing : dye, latex and UV inks.



Le chanvre et le coton ici utilisés poussent rapidement, consomment peu d'eau et ne nécessitent pas de pesticides. Elles produisent rapidement une biomasse qui fixe le CO₂.
100% végétal
100% recyclable

*The hemp and cotton used here grow quickly, consume little water and do not require pesticides. They quickly produce biomass which fixes CO₂.
100% vegetal
100% recyclable*



**LINEN DROP®**

Design Desigual

LINEN DROP®



Non tissé 65 % Lin et 35 % Viscose (cellulose régénérée), disponible en coloris greige.

Non woven of 65% Linen and 35% viscose (regenerated cellulose) fiber, available in gray color.



Classé non feu M1.

Fire resistant M1.



Intérieur.
Décoration murale.

*Indoor.
Wall decoration.*

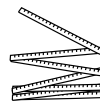

130 gr/m²
Laize de 2,20 m
Rouleaux de 100 mètres linéaires

*130 gr/m²
2,20m / 86.59" wide
Rolls of 100 ml*



Impression numérique à base aqueuse, encres latex et UV.

Digital printing : dye, latex and UV inks.



100% végétal
100% recyclable
100% biodégradable
Peut se coudre et se coller

*100% vegetal
100% recyclable
100% biodegradable
Can be sewn and glued.*

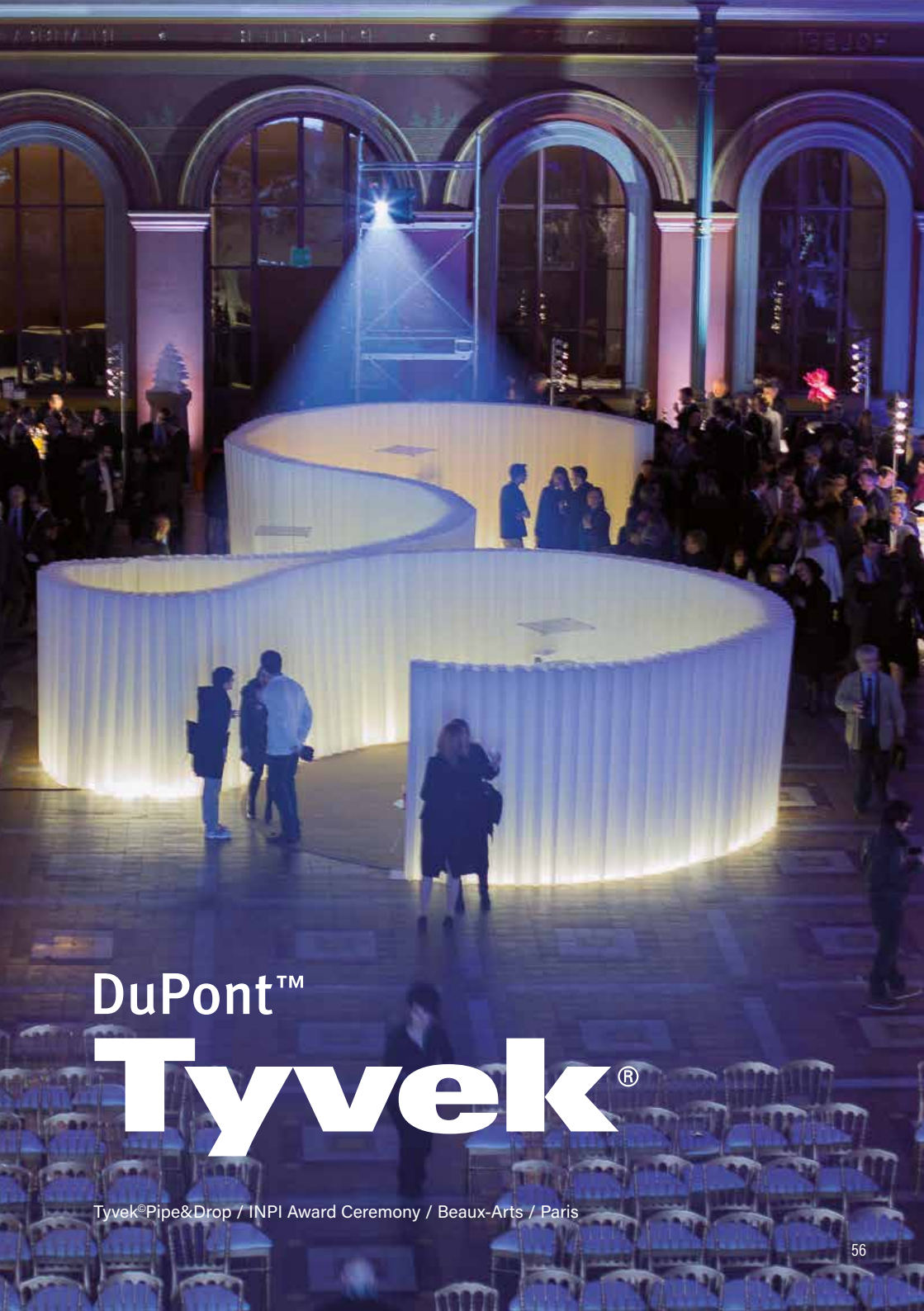

DuPont™ Tyvek®

Tyvek®Pipe&Drop / INPI Award Ceremony / Beaux-Arts / Paris

DuPont™ Tyvek®



DuPont™ Tyvek® est un non-tissé extrêmement résistant, fabriqué en fibres de polyéthylène haute densité. Tyvek® est léger, lisse et indéchirable.

DuPont™ Tyvek® is made of pure high density polyethylene fibers. Tyvek® is extremely resistant, light, smooth and tear-resistant.



Classé non feu B1.

Fire resistant B1.

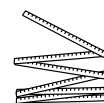

140 gr/m².
Laize 1m.

*140 gr/m².
Width 1m / 39.3"*



Réalisation de murs Pipe&Drop. Tyvek® ajoute résistance et longévité au produit.

Pipe&Drop walls. Tyvek® brings resistance and longevity to this product.



Encre UV ou latex.

UV ink and latex.



Grande résistance mécanique.
Opacité 97 %.
Garantie sans antimoine et produits halogénés.

*High mechanical strength.
97% opaque.
Without antimony or halogenated products.*

DuPont™ et Tyvek® sont des marques ou marques déposées de E.I. du Pont de Nemours ou de ses sociétés affiliées.



HONEYCOMB®



Nid d'abeille en Drop Paper®.

Honeycomb made out of Drop Paper®.



Classé non feu M1, Euroclass Cs3d0.

Fire resistant M1, Euroclass Cs3d0.



Drop Paper® 60 gr/m². Bandes de 1,40 m repliées et 1,00 m dépliées.

Drop Paper® 60 gr/m². Stripe flat : 1,40 m / 55" - stretched stripe: 1 m / 39,37"



Faux plafond, cloisons, mobilier...

Ceilings, lightings, banners and displays, furniture...



15 couleurs standards.

15 standard colours.

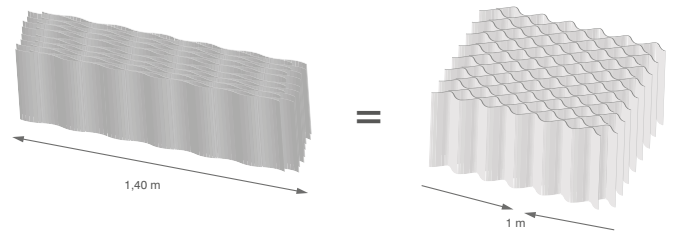
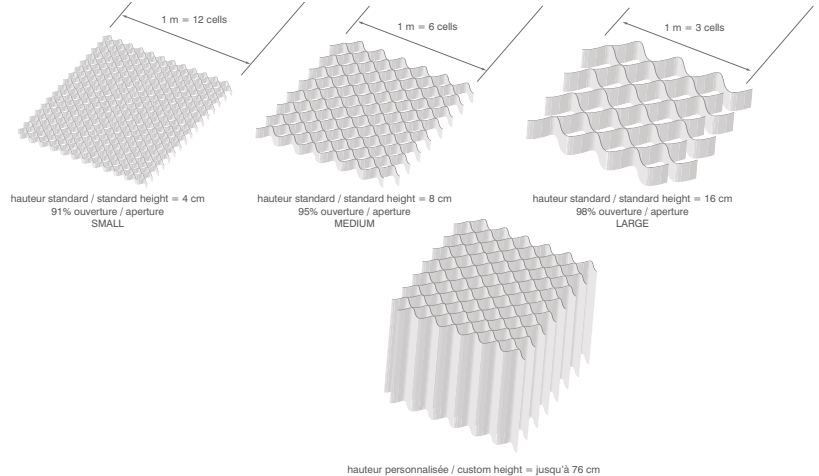

La largeur est réduite quand les alvéoles sont étirées / Width is reduced when the cells are stretched

HONEYCOMB®

Exposition Architectures de papier
Cité de l'Architecture



SMOKE OUT®

Musée du Quai Branly
Design Jean Nouvel

SMOKE OUT®

Le Smoke Out est un tricot à mailles bloquées extensible en Trévira CS, classé non feu M1 et destiné à la réalisation de plafonds masquants temporaires de sécurité. Ses lignes fusibles tous les 33 cm permettent en cas d'incendie l'évacuation des fumées par l'ouverture automatique du textile et le déclenchement des sprinklers.



Smoke Out is a stretch knitted fabric made of Trevira CS for temporary masking and security ceilings. The melting lines every 33 cm (12") provide, in case of fire, automatic opening to enable smoke to escape and sprinkler to shower the fire.



Classé non feu M1.

Fire resistant M1.

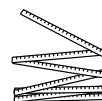

Existe en rouleaux de 50 ml.
2,80 m de largeur extensible à 3 m.

*Rolls of 50 lm.
2,80 m (110') wide, stretchable to 3 m (118").*



Existe en blanc et noir.
Le textile doit être tendu avec attention pour être efficace.
Il peut être fixé sur cadre aluminium avec du velcro
ou agrafé sur châssis bois.

*Available in white and black.
The textile shall be very well stretched in order to be efficient.
We can set up Smoke Out onto aluminium frame with velcro tape or staple it on a wooden frame.*



Assemblage par coutures zig zag. S'installe agrafé sur châssis ou fixé sur bande velcro.

Overlap the stretchable fabric and sew with zigzag stitches to assembly Smoke Out.





HARU

stuck-on
design;

Rubans adhésifs fabriqués par HARU, distribués en exclusivité en France par Procédés Chénel. Une solution facile et inventive pour personnaliser tous vos espaces !



*Exclusively distributed in France by Procédés Chénel.
An easy and inventive solution to custom all spaces!*

Ces rubans adhésifs sont disponibles en 8 familles de couleur unies différentes, en 2 familles de motifs différents, en 3 matériaux différents (Washi Tape, PET Tape, OPP Tape transparent) et 4 largeurs (50mm, 150mm, 300mm or 600mm)

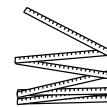

These tapes are available in 8 different families of solid colors, 2 families of patterns, 3 different materials (Washi Tape, PET Tape, OPP Tape transparent) and 4 width (50mm, 150mm, 300mm or 600mm).

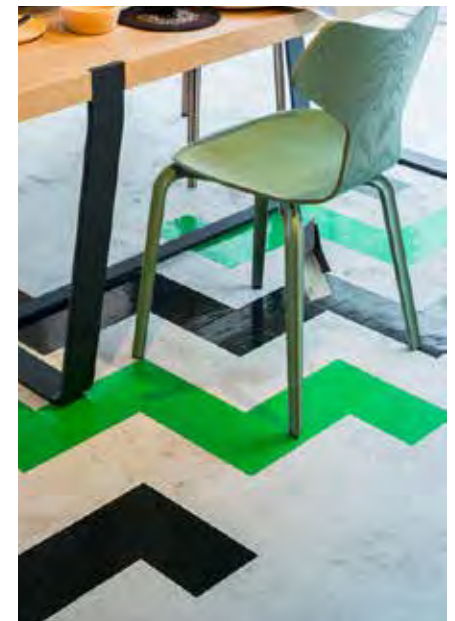
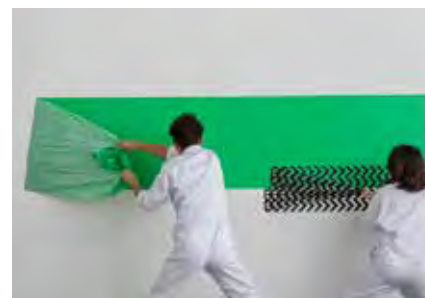



SWEDBOARD[®]



SWEDBOARD[®] Fibre est un panneau rigide en carton nid d'abeille certifié FSC[®]. Disponible en blanc et brun kraft.

SWEDBOARD[®] Fibre is a honeycomb cardboard made of FSC[®] certified paper. Available in white and kraft brown.



B-s1,d0 pour les panneaux blancs.

B-s1,d0 for the white panels.



Displays, points de vente, mobilier, cloisons, expositions...

Displays, Points of Sale, Furniture, Partitions, Exhibitions...

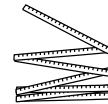

Épaisseur de 10mm et 16mm.
Largeur jusqu'à 2400mm.

*10mm and 16mm thick.
Width up to 2400mm.*



Imprimable, table à plat

Printable, flat table



100% renouvelable.
Haute proportion de contenu recyclé.
100% recyclable.

*100% renewable.
High proportion of recycled content.
100% recyclable.*



DROP[®] CAKE

turning paper waste into recycled boards

Panneaux rigides fabriqués à partir de chutes de production de Drop[®] Paper. Composé de 60 % de déchets de Drop[®] Paper et 40 % de déchets de polyéthylène. Chaque plaque permet de recycler environ 270 m² de Drop[®] Paper.

1m² de Drop[®] Cake = 10kg = 100 m² de papier transformé.



Rigid panels made out of Drop[®] Paper production waste. Composed of 60% Drop[®] Paper waste and 40% polyethylene waste. Each board corresponds to approximately 270m² of Drop[®] Paper. 1m² of Drop[®] Cake = 10kg = 100 m² of transformed paper.

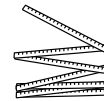

Plaque de 1,25 x 2,40 et 1 x 2,50 m
Épaisseur 8-9 mm

*1,25 x 2,40 m / 49.21" x 94.48" and 1 x 2,50 m / 39.37" x 98.42" boards
Thickness 8-9 mm*



- Flocons de papier pressés à chaud, aucun ajout de produit chimique
- Recyclable à l'infini
- Idéal pour mobilier, luminaire, PLV, cabanes...
- Délai 4 semaines minimum

- *Hot pressed paper flakes, no chemical addition.*
- *Infinitely recyclable*
- *Ideal for furniture, lighting, POS, cabins...*
- *4 week deadline*

NB. Coloris non contractuels / *Non-contractual colors*



LES APPLICATIONS

THE APPLICATIONS



PLAFONDS

CEILINGS



PLAFONDS[®]
HONEYCOMB
 CEILINGS

Le plafond en papier Honeycomb est une nappe d'alvéoles en nid d'abeille pour masquer efficacement toutes les vues supérieures des halls.



Honeycomb paper ceiling[®] is a succession of honeycomb paper cells to mask any upper views of the exhibition halls.



Classé non feu M1.
Fire resistant M1.

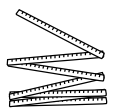

3 formats standards :
 H 4 cm / 12 alvéoles et H 8 cm / 6 alvéoles et H 16 cm / 3 alvéoles
*3 standard sizes :
 H 4 cm / 12 cells and H 8 cm / 6 cells and H 16 cm / 3 cells*

Plafonds de sécurité
 Encore plus masquant
 Léger et élégant. Diffusion des flux lumineux
 Isolant acoustique. Très faible volume
 Pose facile
 3 types de nappes disponibles
 Un large choix de couleurs
 Brevet international



*Security paper ceiling
 Ceiling so masking
 Light and Elegant. Diffusion of light
 Sound absorption, Low volume
 Easy setup
 3 different dimensions, A large range of colours
 International patents*

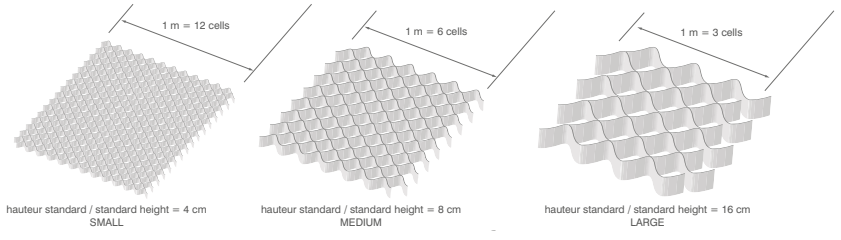

PLAFONDS[®]
HONEYCOMB
 CEILINGS

Stand Pink Lady
 Design Sted Bis - Laurent Boaretto



Citibank Singapour, design by : Hoa Huang/Nigel Liau, Geyer Environments Pte Ltd



PLAFONDS®
HONEYCOMB
CEILING S

Krekenavos Park exhibition,
design : Skirmante Vaitkeviciute



DROP[®] STRIP E

Equip'hotel, design Elisabeth Leriche

DROP[®] STRIP E

Système de faux-plafond en bandes de Drop Paper[®] parallèles tendues dans un plan vertical. Ces bandes décoratives, compatibles avec tous les systèmes de sécurité, peuvent également devenir supports de signalétique.



Ceiling system made of parallel strips of Drop Paper[®] stretched in a vertical plane. Compatible with any security systems, these strips can also be used as graphic support.



Classé non feu M1, B1.

Fire resistant M1, B1.

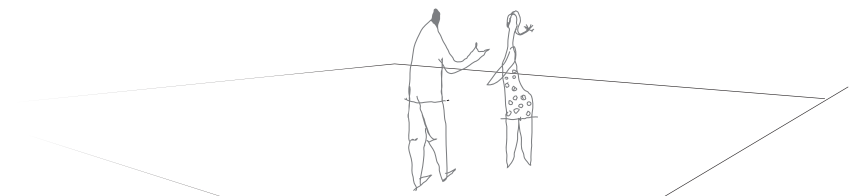
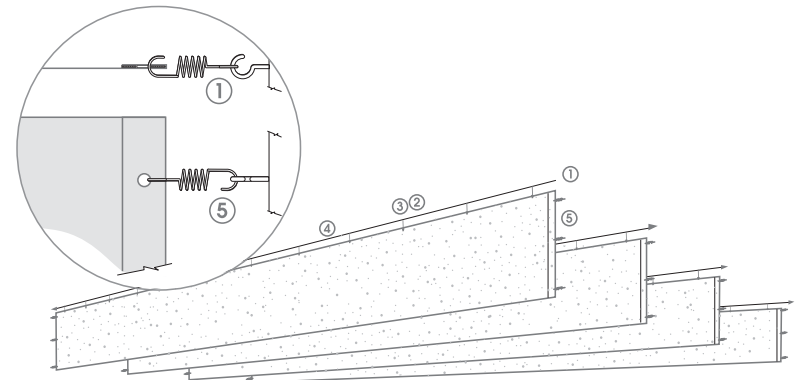



DROP[®] STRIPE

Drop Stripe, Carrefour Nice, design: Generous Branding



DROP[®] STRIPE

Carrefour Sartrouville, Design : Marc Sitbon



LASER DROP®

LASER DROP®



Découpe sur Drop Paper® blanc ou couleur de tous motifs vectorisés, standards ou sur mesure.

Cut on white or coloured Drop Paper® of any vectorised, standard or custom design.



Classé non feu M1, B1.

Fire resistant M1, B1.



LASER DROP[®]

Stand Land Rover



DROP® GONDOLA largeur

Les bandes de Drop Paper® sont simplement suspendues par leurs extrémités à des points d'accrochage supérieurs, à l'aide de tubes aluminium passés dans des ourlets simples.

Le galbe se fait naturellement en fonction des points d'accroche et de la longueur des bandes.



Drop Paper® strips are simply hung to upper frame or structure by means of aluminium tube in a simple hem. The vault will be custom made depending on the width of the upper structure and the length of stripe.



Classé non feu M1, B1.

Fire resistant M1, B1.

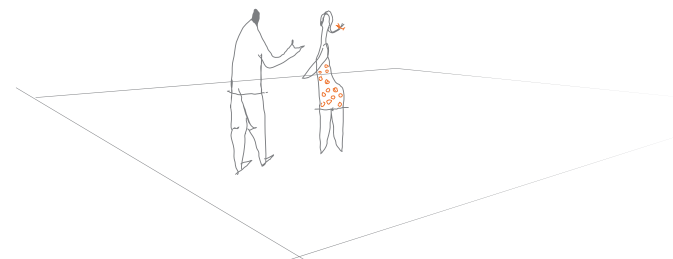
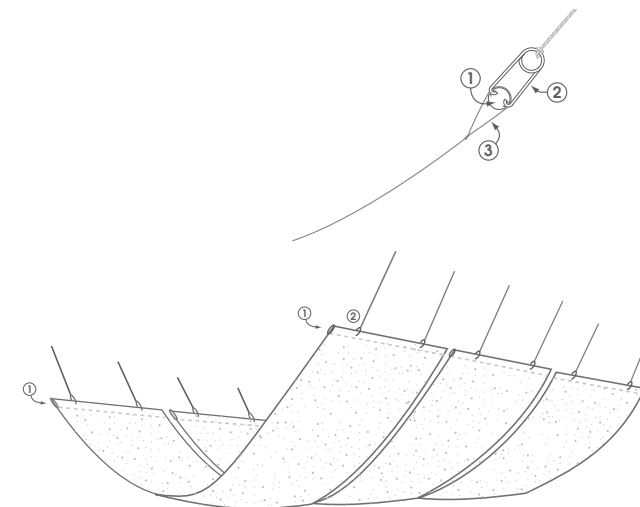

DROPP® GONDOLA

Stand de la ville de Turin
Design by Carlo Viano

GRANDFORM

SEA

SEA

Sardane

Pasodoble

DROP[®]
GONDOLA





DROP® GONDOLA

Exposition Man Ray

DROP® GONDOLA longueur

Bandes de Drop Paper® cintrées en demi cercle dont les deux extrémités sont collées sur une plaque aluminium cintrée et percée. Comme pour le Drop Stripe®, de petites agrafes suspendent les gondolas tous les 60 cm à un câble d'acier tendu au-dessus.



Ceiling system made of Drop Paper® strips vaulted in half circle. Ends are stricked on a pre-vaulted aluminium stripe with holes. As for Drop Stripe®, small dips hang the paper on a stretched upper steel cable every 60 cm(23').



Classé non feu M1, B1.

Fire resistant M1, B1.

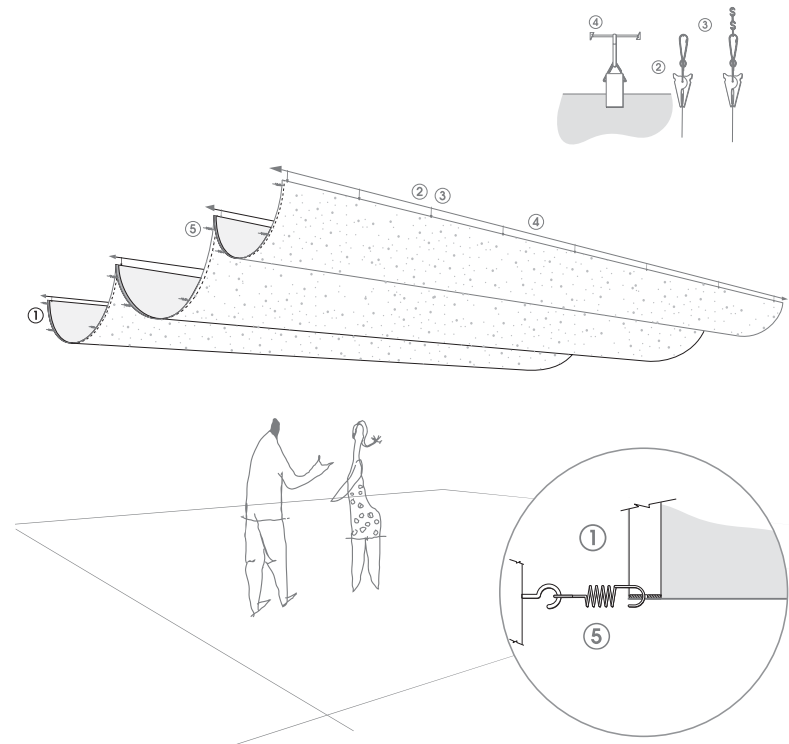



CRISTINA

DROP®
GONDOLA

Stand Cristina, Design Makio Hasuike & Co



PLAFONDS
**PARA
LUME**[®]
CEILINGS



Les plafonds Paralume utilisent les qualités du Drop Pape[®] en réalisant des réseaux d'alvéoles juxtaposées ouvertes dans le sens vertical.

The Paralume ceilings benefit from the Drop Paper[®] qualities making a network of large vertical open cells.



Classé non feu M1, B1.

Fire resistant M1, B1.



- Vision masquée quelque soit l'angle
- Respect des règles de sécurité
- Facilité d'installation sur pont lumière
- Variation de translucidité
- Luminescence variable
- Possibilité de relief 3D
- Possibilité d'intégrer les perforations du Laser Drop[®].

- *Obscured sightlines regardless of viewing angle*
- *Respect of the security regulations*
- *Easy set up on upper structure*
- *Variation of translucency*
- *Graduation of lighting*
- *Three-dimensional option*
- *Laser Drop[®] option*



PLAFONDS
**PARA
LUME**[®]
CEILINGS



PLAFONDS
**PARA
LUME**[®]
CEILINGS



Citibank Singapour, design by : Hoa Huang/Nigel Liao
Geyer Environments Pte Ltd



WAVY



SMOKE OUT®

COMMANDE DE SMOKE OUT® / ORDERING SMOKE OUT®

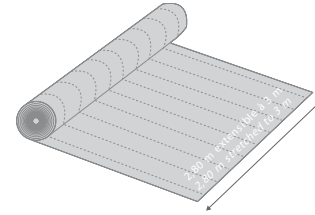

Le Smoke Out® se présente en laize de 2,80 m extensible à 3 m. Important : le Smoke Out® est livré en rouleaux sous tension. Le ruban en papier décimétrique indique la longueur de Smoke Out® nécessaire pour réaliser un lè de plafond tendu. En revanche, le Smoke Out® n'est pas tendu en largeur de laize sur le rouleau. Les 2,80 m environ apparents, doivent être complétés pour couvrir 3 m de large.

Exemple : pour réaliser un plafond de 50 m x 15 m, compter 5 rouleaux de 50 m de long (15 : 3 = 5) et réaliser 4 coutures en zig zag.

Smoke Out® is sold in widths of (94 inches) and can stretch to 3 inches). Important : Smoke Out® is delivered rolls that are under tension in the A measuring tape is rolled with it duct to show the tensioned length roll. The width of the fabric is not tension and can be stretched up when installed.

Example : to achieve a ceiling of 15 m wide you need 5 rolls of 50 (3 = 5), and 4 zig zag sewings.

POSE DU SMOKE OUT® / HANGING SMOKE OUT®

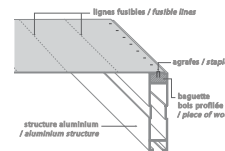

Le Smoke Out® est facile à poser. Il peut être agrafé en périphérie sur des lisses de bois et fixé sur ou sous des structures aluminium classiques après avoir placé dans les gorges de celles-ci des baguettes profilées en bois.

Smoke Out® is easy to work with. be stapled to wood frames or stc aluminium structures once wood are placed in the grooves.

FIXATION DU VÉLUM SMOKE OUT® / SMOKE OUT® SETTING UP

Sur un cadre aluminium avec une bande velcro (côté mâle) adhésivé sur un cadre aluminium
Smoke Out stretched on a velcro tape adhesived on an aluminium frame.

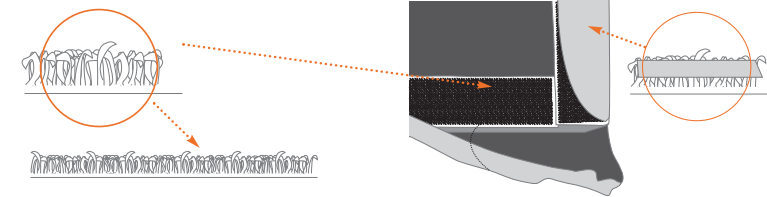

GRAND VELUM / LARGE HUNG CEILINGS

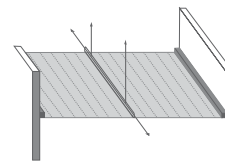

Comme le vélum classique, le Smoke Out® peut être cousu bord à bord par des coutures en zig zag de préférence et soutenu par un fil de fer passant dans des coulisses. À leur tour, ces fils sont soulagés par des suspentes dans le cas de grands véllums. Il n'est pas nécessaire d'établir des réseaux de fils sous le Smoke Out®.

As with classic hung ceilings, Smoke Out® can be sewn selvage to selvage with zig zag sewing, and held will slipped into the hems. In the c large hung ceilings, the hem wire held to the building structure by v wires. It is not necessary to set up network under Smoke Out®.

SMOKE OUT®



Votre Fragment...
La touche complaisante. Elle était au service du sujet, le glorifiant. Le...
saisir le geste, de sentir de le toucher. Ce fut en quelque sorte le...

SMOKE OUT



SMOKE OUT





CLOISONS

PARTITIONS



PIPE &

DROP PAPER
DROPSCREEN



Système de paravent autostable en Drop Paper®. En option, platine de stabilisation.

Self standing partition made of Drop Paper®, Optional: steel base with aluminium tube.



Classé non feu M1, B1, NFPA 701.

Fire ratings M1, B1, NFPA 701.

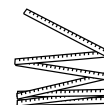

Hauteur 1m ou 2m, déployable jusqu'à 5m, largeur environ 35cm.

1 or 2 m high, stretchable to 5 m, about 35 cm wide.

- Léger et élégant
- Facilité d'installation
- Diffusion des flux lumineux
- Bonne absorption phonique
- Très faible volume
- Un large choix de couleurs
- Possibilité d'impression de motifs
- Possibilité de découpe laser
- Brevet international



- *Light & Elegant*
- *Easy set up*
- *Diffusion of light*
- *Good phonic absorption*
- *Low volume*
- *A large range of colours*
- *Can be printed*
- *Can be laser cut*
- *International patents*

PIPE &

DROP PAPER
DROPSCREEN



PIPE & DROP
DROPPAPER
DROPSCREEN

Custom Pipe&Drop, showroom PCI



PIPE & DROP
DROPPAPER
DROPSCREEN



**LASER
DROP®**

LASER DROP®



Découpe sur Drop Paper® blanc ou couleur de tous motifs vectorisés, standards ou sur mesure.

Cut on white or coloured Drop Paper® of any vectorised, standard or custom design.



Classé non feu M1, B1, NFPA 701.

Fire rated M1, B1, NFPA 701.



Laser Drop® Anne-Lise Vernejoul / Photo Sophie Delaporte



PRODUIT
RHÔNE-ALPES
GUILLOT COBREDA

RhôneAlpes

GUILLOT
COBREDA
24 08

GUILLOT
COBREDA
24 08

GUILLOT
COBREDA
24 08

GUILLOT
COBREDA

GUILLOT
COBREDA

COBREDA

GUILLOT
COBREDA

LASER
DROP

® Laser Drop, SIRA exhibition in Lyon, Design X'PO



MODULES
HONEYCOMB
MODULES



Honeycomb Modules vous permet de créer des parois courbes ou droites en superposant des modules.

Honeycomb Modules is a new solution to create vertical partitions straight or curved by stacking modules.



Classé non feu M1, B1, NFPA 701.

Fire ratings M1, B1, NFPA 701.

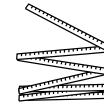

20 cm d'épaisseur et 35,7 cm de hauteur.

20 cm thick and 35,7 cm high.



- Cloison courbe ou plane
- Légère et élégante
- Diffusion des flux lumineux
- Bonne absorption phonique
- Très faible volume
- Pose facile
- Réutilisable
- Un large choix de couleurs

- *Curved or planed partition*
- *Light & Elegant*
- *Diffusion of light*
- *Good phonic absorption*
- *Low volume*
- *Easy set up*
- *Reusable*
- *International patents*

MODULES
HONEYCOMB
MODULES

Honeycomb modules



MODULES
HONEYCOMB
MODULES

Women's Forum, design StudioZ



CLOISONS[®]
HONEYCOMB
PARTITIONS

CLOISONS[®]
HONEYCOMB
PARTITIONS



La cloison Honeycomb[®] est une nappe d'alvéoles en nid d'abeille pour partitionner l'espace.

Honeycomb partition[®] is a succession of honeycomb cells to make separations.



Classé non feu M1, B1, NFPA 701.

Fire ratings M1, B1, NFPA 701.

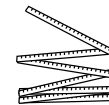

2 formats : 8 cm et 16 cm

2 different depth : 8 cm and 16 cm



- Cloison courbe ou plane
- Légère et élégante
- Diffusion des flux lumineux
- Bonne absorption phonique
- Très faible volume
- Pose facile
- 3 types de nappes disponibles
- Un large choix de couleurs
- Brevet international

- *Curved or planed partition*
- *Light & Elegant*
- *Diffusion of light*
- *Good phonic absorption*
- *Low volume*
- *Easy set up*
- *3 different dimensions*
- *A large range of colours*
- *International patents*



LIGHTED WALL

LIGHTED WALL

CLOISON EN PAPIER AUTOSTABLE JUSQU'A 5 METRES !

Système de cloison en papier avec structure intérieure permettant une hauteur de 5 mètres.

La structure métallique intérieure permet l'installation de l'éclairage et sa diffusion par les écrans en papier Drop Paper® imprimables, suspendus et lestés en partie basse.



SELF STANDING PAPER WALL UP TO 5 METERS HIGH

Modular system to build self standing illuminated paper partitions up to 5 m high.

The structure enables lighting to be set up inside, which is diffused by the Drop Paper® screens, printable, hung and weighted.



Classé non feu M1, B1, NFPA 701.

Fire rated M1, B1, NFPA 701.

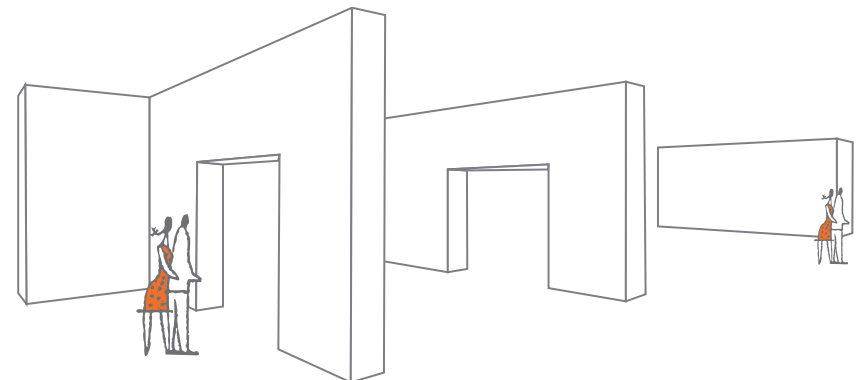



GROW UP by FLAVIE+PAUL

GROW UP by FLAVIE+PAUL

Conçu par Flavie+Paul pour Procédés Chénel International, Grow up est une cloison en papier, ré-interprétation du mur végétal. Des motifs végétaux pré-découpés sont juxtaposés les uns sur les autres. Un mur de papier pourvu d'interstices en forme de croix vient les recouvrir. En passant sa main au travers des croix, l'utilisateur attrape les végétaux et les fait ressortir sur l'avant du mur. L'utilisateur vient ainsi composer son mur suivant ses besoins et envies : il le modifie, le grandit, l'épaissit, le fait foisonner. Grow up est composé de modules qui peuvent facilement s'adapter à plusieurs types d'espaces, tant dans un but séparatif que décoratif.



Designed by Flavie+Paul for Procédés Chénel International, Grow up is a paper partition wall, re-interpreting the idea of a vegetal wall. Pre-cut vegetal patterns are juxtaposed and placed behind a paper wall which has several cross-shaped cut. The user is then free to grasp the vegetal patterns through the cuts and bring them up front. The wall is therefore each time unique, made up depending on the user's desires. Grow up consist of modules, which can easily fit to many spaces, being a partition as well as a decoration.



Classé non feu M1, B1, NFPA 701.

Fire rated M1, B1, NFPA 701.





KIRIGAMI

design Janique Bourget

3 rails coulissants parallèles
3 panneaux Drop® suspendus dim. 1,50 m x 2,35 m de hauteur
Plat aluminium et étiré de lestage en partie basse
Découpages 1,20 m x 0,60 m



*Parallel sliding rails
3 suspended Drop® panels, dim. 1,50 x H2,35m
Flat aluminium profile and ballast at the bottom
Cutting up 1,20 x 0,60m*



Classé non feu M1, B1, NFPA 701.

Fire rated M1, B1, NFPA 701.

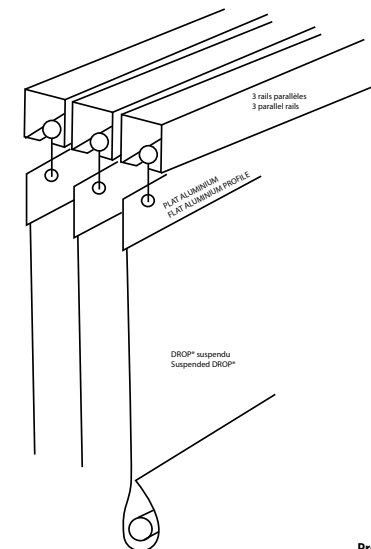

KIRIGAMI
design Janique Bourget



Cloison
AirDROP®
PartitionWall

Cloison **AirDROP®** PartitionWall

Cloison ajourée

- Dimensions : 0,80 m de largeur x hauteur variable jusqu'à 3,50 m environ.
- 3 modèles standards, possibilités de perforations de formes différentes.
- Système d'accrochage simple, tube aluminium et lestage inox.
- 15 couleurs standards.



Openwork Origami partition wall

- Dimensions: 0.80m width x up to 3.50m approximately in height.
- 3 standard references, various types of perforations possible.
- Simple hanging system, aluminium tube and stainless steel ballasting.
- 15 standard colors.

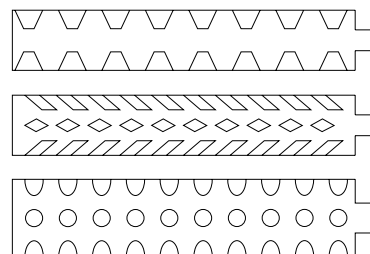



IGLOO



Une succession d'écrans découpés selon le motif désiré.

A succession of cut screens, any design possible.



Classé non feu M1, B1, NFPA 701.

Fire rated M1, B1, NFPA 701.



Conception Nadia Lauro.
Projet "La Clairière" pour "Un nouveau festival" au centre Pompidou



Cloison Vanves



Cloison en carton alvéolaire haute densité, livrée en kit, design Grégoire Borach.
Existe en blanc, classé au feu CS1D0 et en kraft.
L 1,00 x H 2,50 x P 0,28 m / 6,5 kg.

*Partition made of high density honeycomb structured cardboard, to set up, design Grégoire Borach. Available in white, fire retardant CS1D0 and brown.
L 1,00 x H 2,50 x P 0,28 m / 6,5 kg.*



Cloison Drop Room[©]



Espace cabane, design Grégoire Borach. Fabriqué en carton alvéolaire de haute densité et nid d'abeille. Existe en blanc, classé au feu CS1D0 et en kraft.

A hut space, design by Grégoire Borach, made out of honeycomb cardoard and Drop Paper Honeycomb. Available in white, fire retardant CS1D0 and brown.

STRUCTURE BLANC	1,49m L x 2,30m Ht x 0,40m P	15 kg
STRUCTURE KRAFT	2,70m L x 2,30m Ht x 1,40m P	15 kg
HONEYCOMB BLANC	1,38m L x 0,80m Ht x 0,20m P	3 kg
HONEYCOMB COUL	1,38m L x 0,80m Ht x 0,20m P	3 kg
DROP BLANC	1,38m L x 0,80m Ht x 0,20m P	3 kg
DROP IMPRIME	1,38m L x 0,80m Ht x 0,20m P	3 kg





Drop Room[©]



Espace cabane, design Grégoire Borach. Fabriqué en carton alvéolaire de haute densité et nid d'abeille. Existe en blanc, classé au feu CS1D0 et en kraft.

A hut space, design by Grégoire Borach, made out of honeycomb cardoard and Drop Paper Honeycomb. Available in white, fire retardant CS1D0 and brown.

STRUCTURE BLANC	2,70m L x 2,30m Ht x 1,40m P	15 kg
STRUCTURE KRAFT	2,70m L x 2,30m Ht x 1,40m P	15 kg
HONEYCOMB BLANC	1,38m L x 0,80m Ht x 0,20m P	3 kg
HONEYCOMB COUL	1,38m L x 0,80m Ht x 0,20m P	3 kg
JONCTION BLANC	2,70m L x 0,20m Ht x 1,25m P	3 kg
JONCTION KRAFT	2,70m L x 0,20m Ht x 1,25m P	3 kg
HONEYCOMB BLANC	2,70m L x 0,20m Ht x 1,25m P	3 kg
HONEYCOMB COUL	2,70m L x 0,20m Ht x 1,25m P	3 kg



InfraSystem®

design Grégoire Borach

L'InfraSystem® est un système constructif breveté permettant de créer des structures tubulaires à l'aide de connecteurs multidirectionnels simples et répliquables. L'InfraSystem® est un outil de créations spatiales, un générateur de produits d'espace nommés Infras (InfraWall, InfraRoom, InfraCorner etc.)

The InfraSystem® is a patented construction system allowing the creation of tubular structures using simple and replicable multidirectional connectors. The InfraSystem® is a spatial creation tool, a generator of space products called Infras (InfraWall, InfraRoom, InfraCorner etc.)

- Tubes en carton, diamètre intérieur 76 mm, diamètre extérieur 88 mm. Longueur 2,40 m maximum. Ré-employable et recyclable.
- Drop®Paper. Non-tissé en cellulose, polyester et fibre de verre. Classé non feu M1, B1, Class 1, NFPA 701. Usage intérieur. Upcyclable.
- Câbles et tendeurs en acier. Pièces pré- montées. Ré-employables et recyclables.
- Connecteurs multidirectionnels en peuplier. Pièces pré-montées et gravées. Ré-employables et recyclable.

- Cardboard tubes, internal diameter 76 mm, external diameter 88 mm. Length 2.40 m maximum. Re-usable and recyclable.
- Drop®Paper. Nonwoven in cellulose, polyester and fiberglass. Fire rated M1, B1, Class 1, NFPA 701. Indoor use. Upcyclable.
- Steel cables and tensioners. Pre-assembled parts. Re-usable and recyclable.
- Multidirectional poplar connectors. Pre-assembled and engraved parts. Re-usable and recyclable.

InfraRoom
from the InfraSystem®

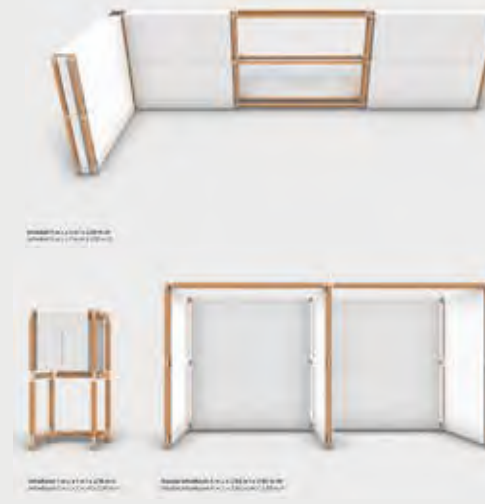

InfraRoom 2,50 m L x 2,50 m H x 2,50 m HT
InfraRoom 2,50 m L x 2,50 m H x 2,50 m HT





VAUREAL

design Auriane Boucher

Cloison en Hard Drop

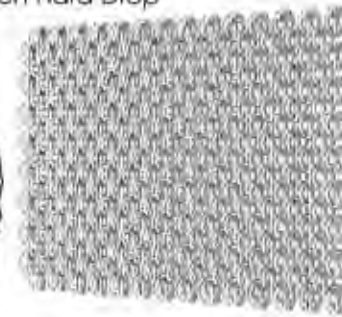

64 pièces/m²



Cloison en Reboard 10mm

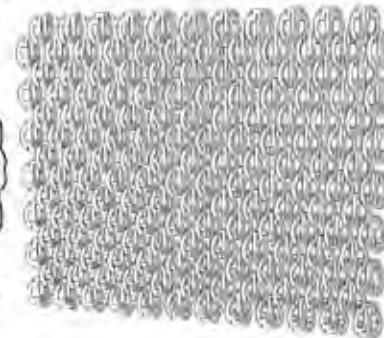

40 pièces/m²



Cloison en Reboard 16mm

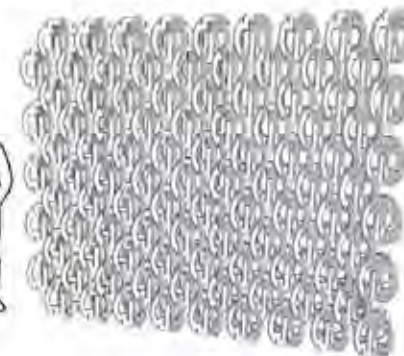

24 pièces/m²





LUMINAIRES

LIGHTING

Carrousel du Louvre, design by Pascale Rabaud, architecte dplg



LIGHTED DROP®

LES LUMAIRES EN PAPIER

Éléments lumineux décoratifs en papier de formes et dimensions variables en Drop Paper® classés non feu M1, autostables ou suspendus.

L'éclairage intérieur du luminaire en papier peut être créé par des fluos de couleur pour obtenir toute une variété de nuances.

Disponibles en vente et location.



VARIETY AD INFINITUM OF PAPER LIGHTINGS

Decorative illuminated elements made of Drop Paper® of various shapes and sizes, fire retardant, hung or self-standing. Coloured fluo tubes add a large range of lighting effects.

Available for purchase or rent.

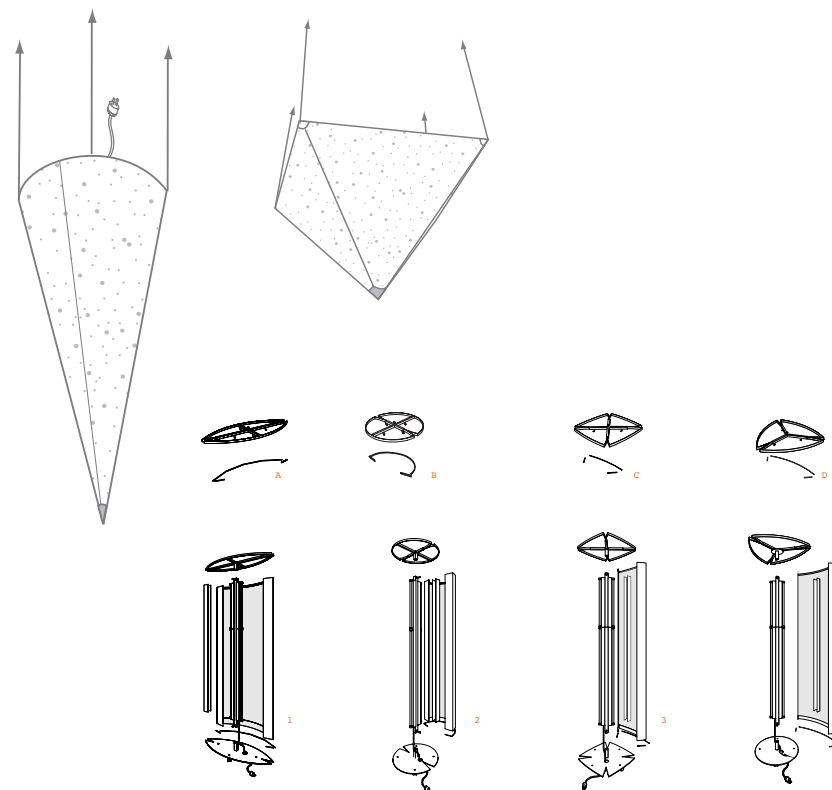

LIGHTED
DROP®



L I G H T E D
D R O P[®]

Grand Café d'Orléans au Château de Versailles
Design Atelier Canal



LIGHT COLUMN

By Procédés Chénel® International

LIGHT COLUMN

By Procédés Chénel® International



MONTAGE EXPRESS !

Élément lumineux en PVC transparent, recouvert d'un visuel interchangeable.

EXPRESS SET UP

Illuminated element made of transparent PVC transparent, covered with exchangeable graphics.

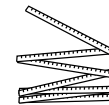

Existe en 2m et 2,35m de haut et version mini (35cm de haut).

Exists in 2m00 and 2m35 high and a mini version (35cm high).



LIGHT COLUMN

By Procédés Chénel® International



LIGHT MODULES

design by Ralston&Bau

LIGHT MODULES est un système d'éclairage en papier permettant de créer plafonds et éléments lumineux monumentaux sur-mesure pour des espaces permanents et provisoires. L'utilisation du papier apporte une grande légèreté d'installation tout en diffusant subtilement la lumière. LIGHT MODULES permet de transformer un plafond en une installation dynamique et lumineuse. Les trois tailles de cadres et les hauteurs variables du papier permettent de créer une quantité infinie de plafond en 3 dimensions et de multiples lustres.

Quatre combinaisons standard d'installation sont illustrées dans ce document.

La structure est composée de cadres en aluminium puis fixée ou suspendue au plafond. Les abat-jours sont faits en Drop Paper, papier durable et non inflammable.

Le Drop Paper existe en plusieurs couleurs, épaisseurs et peut également être imprimé de tout motif.



LIGHT MODULES is a paper lighting system creating monumental on-measure lighting and ceiling for permanent and temporary spaces. Using paper gives large installations lightness and softly diffuse the light in the interior. The simple Light Modules system make the ceiling into a living and lit-up installation. The three module sizes and the adjustable height of each module, makes it possible to create an endless amount of 3 Dimensional ceiling landscape and chandelier designs. On the following pages you can discover four basic combinations possible to make.

The system grid is made of aluminium and is attached onto or hanging from the ceiling and the shades are made out of Drop Paper that is a durable and fire proof paper. The Drop Paper comes in several colours, thicknesses and can also be printed with any pattern.

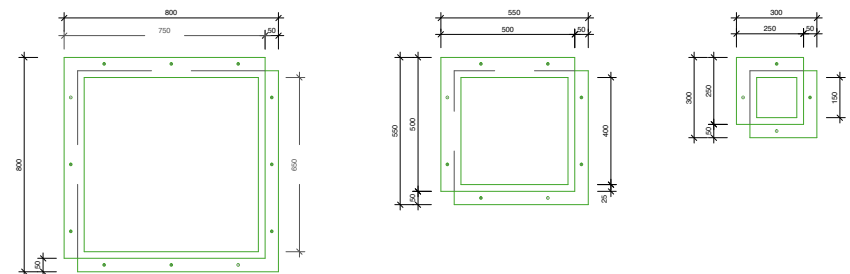

3 cadres en aluminium sont disponibles / 3 aluminium frames are available

LIGHT MODULES

design by Ralston&Bau

LASER LIGHT®

Abat-jour transparent résistant au fil incandescent à 180°C, habillé de Drop Paper® découpé selon motif standard ou personnalisé.



Lamp shade, resistant to 180°C incandescent wire, covered with cut Drop Paper®. Standard or custom design.



LASER LIGHT®





DAISY

design K-now

DAISY

design K-now

Luminaire prêt à suspendre en honeycomb.

Eclairage LEDs.

Dimensions :

- 50 x 11,5 cm
- 80 x 15 cm
- 100 x 15 cm



Ready-to-hang lamp, using Honeycomb.

LED lights.

Dimensions :

- 50 x 11,5 cm
- 80 x 15 cm
- 100 x 15 cm

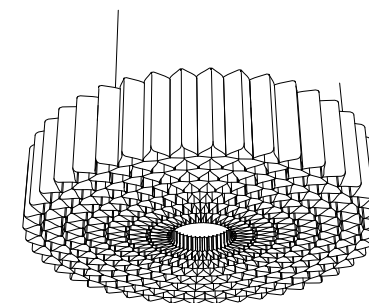
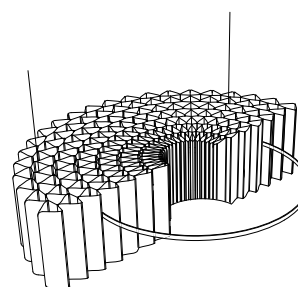



LAMPE
Canopy

LAMPE *Canopy*

- Design : Grégoire Belot
- Origami Drop®, blanc ou imprimé
- M1, B1
- Diamètre : 95 cm ou 75 cm
- Prêt à suspendre



- *Design: Grégoire Belot*
- *Origami Drop®, white or colored*
- *Flame retardant*
- *Diameter: 95 cm ou 75 cm*
- *Ready-to-use*





MANDARINE



- Design by Daniil Danzig / Made By Procédés Chenel international
- Composée de faces découpées en Drop Paper® de toutes les couleurs
- Avec des quartiers de mandarine et de simples boutons pressions, le montage est simple et ludique comme un jeu d'enfant, livrée en kit, prêt à monter.
- Formats possibles : de 30 cm à 1 mètre de diamètre.

- *Design by Daniil Danzig / Made By Procédés Chenel international*
- *Made up of faces cut from Drop Paper® in all colors*
- *With tangerine segments and simple snap buttons, the assembly is as simple and fun as child's play, delivered in a kit, ready to assemble.*
- *Possible formats: from 30 cm to 1 meter in diameter.*





LIGHT ONE



- Lampe en Drop Paper Honeycomb, peut-être fournie avec le dispositif lumineux, soit un socle + douille.
- Hauteurs possibles : de 25 cm à 78 cm
- Existe en blanc et en couleur standard.

- *Lamp made out of Drop Paper Honeycomb, can be supplied with the lighting system, i.e. base and socket.*
- *Possible heights: 25cm to 78cm*
- *Available in white and standard colors*





MOBILIER

FURNITURE



MOBILIER

®

HONEYCOMB

FURNITURE

Une table en papier, Drop Paper plié et collé en nid d'abeilles selon notre technique industrielle Honeycomb.

Epingle de jonction amovible.

Légère et élégante

Facilité d'installation

Diffusion des flux lumineux

Très faible volume

Un large choix de couleurs

Tables rondes, 3 diamètres : 2,60 m, 1,20 m et 0,60 m

3 hauteurs : 0,80 m, 0,60 m et 0,40 m

Plateau en plexi en option



Removable connecting pin.

Light and Elegant

Easy set up

Diffusion of light

Low volume

A large range of colours

Round table : 3 diameters : 2,60 m, 1,20 m et 0,60 m

3 heights : 0,80 m, 0,60 m et 0,40 m

Optional plexi top table



MOBILIER

®

HONEYCOMB

FURNITURE



MOBILIER

®

HONEYCOMB

FURNITURE



MOBILIER

®

HONEYCOMB

FURNITURE



MOBILIER

®

HONEYCOMB

FURNITURE

Honeycomb Modules vous permet de créer des comptoirs en papier en superposant des modules de 40 cm d'épaisseur et 35,7 cm de hauteur sur une structure simple en tube carré laqué.

Ces comptoirs peuvent être lumineux par simple ajout de tubes fluo de 75cm de hauteur.

Finition en partie haute par une plaque en plexi à fixer sur la structure.



Honeycomb Modules is used to make counters. Simply stack different modules of 40 cm thick by 35,7 cm high onto a structure made of white square tube.

*These counters can be lighted with 75cm fluo tubes inside.
Then we place on the top a plexi board simply fixed to the structure.*

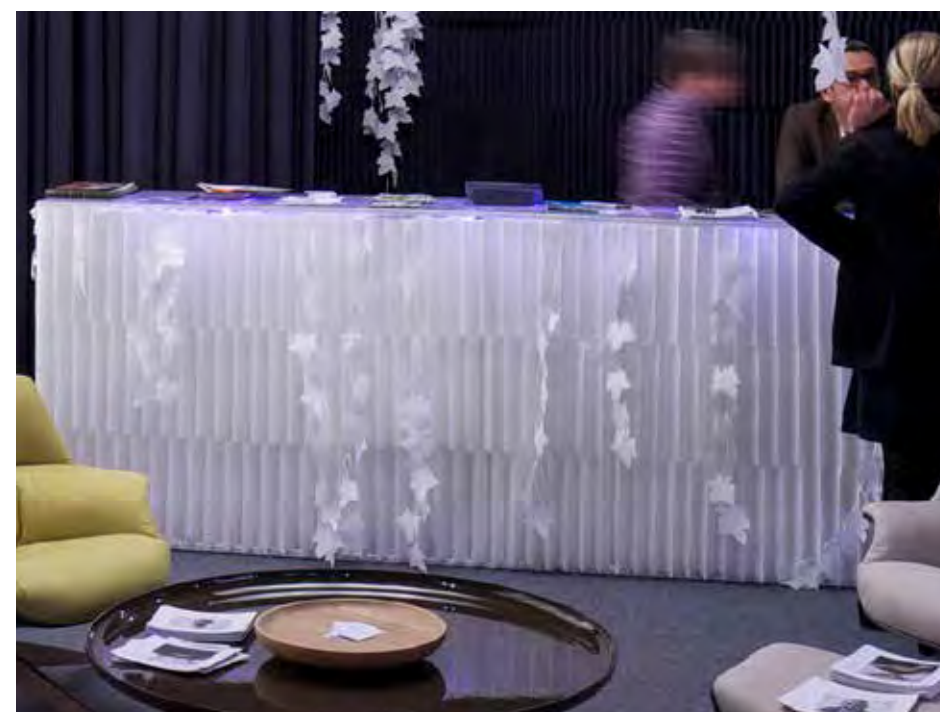

Chaise Vanves



Chaise en carton alvéolaire haute densité, livrée en kit, design Grégoire Borach.
Existe en blanc, classé au feu CS1D0 et en kraft.
L 0,38 x H 0,80 x P 0,50 m / 2,5 kg.

*Chair made of high density honeycomb structured cardboard, to set up, design Grégoire Borach. Available in white, fire retardant CS1D0 and brown.
L 0,38 x H 0,80 x P 0,50 m / 2,5 kg.*

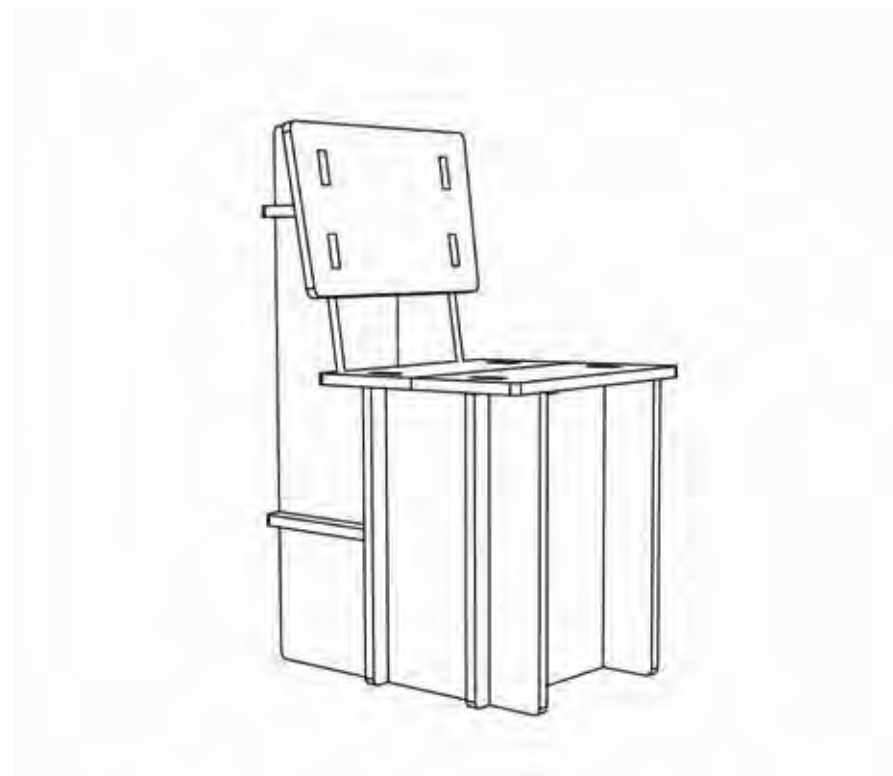

Chaise Ecole Vanves



Chaise en carton alvéolaire haute densité, livrée en kit, design Grégoire Borach.
Existe en blanc, classé au feu CS1D0 et en kraft.
L 0,25 x H 0,55 x P 0,35 m / 0,75 kg.

*Chair made of high density honeycomb structured cardboard, to set up, design Grégoire Borach. Available in white, fire retardant CS1D0 and brown.
L 0,25 x H 0,55 x P 0,35 m / 0,75 kg.*

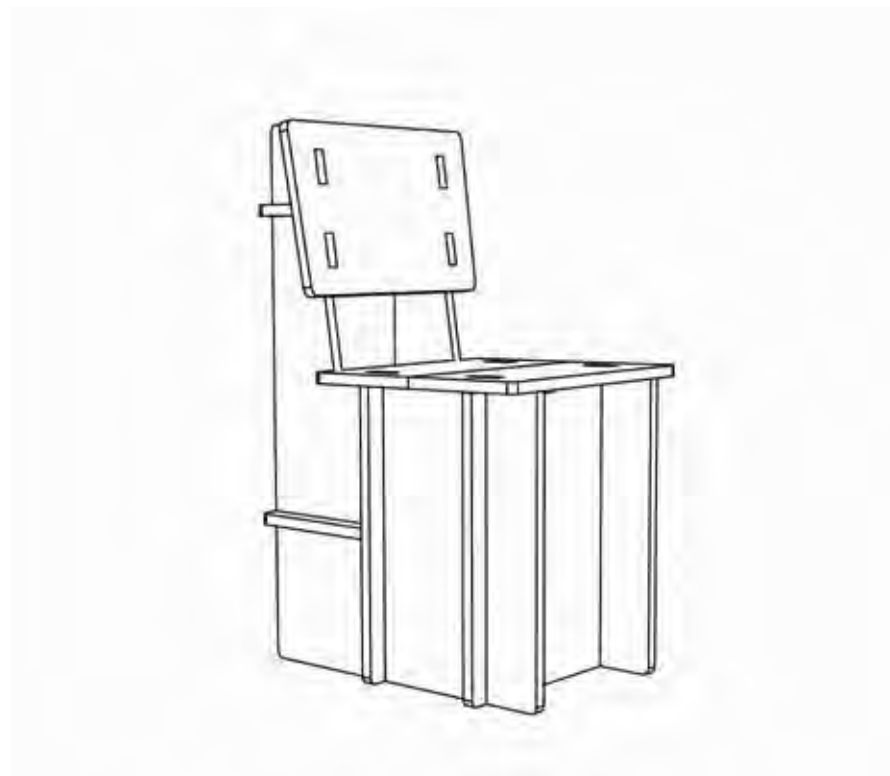

Tabouret Vanves



Tabouret en carton alvéolaire haute densité, livrée en kit, design Grégoire Borach.
Existe en blanc, classé au feu CS1D0 et en kraft.
L 0,31 x H 0,45 x P 0,31 m / 1,4 kg.

*Stool made of high density honeycomb structured cardboard, to set up, design Grégoire Borach. Available in white, fire retardant CS1D0 and brown.
L 0,31 x H 0,45 x P 0,31 m / 1,4 kg.*

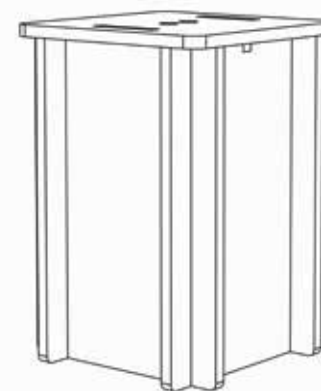

Banc Vanves

Banc en carton alvéolaire haute densité, livrée en kit, design Grégoire Borach.
Existe en blanc, classé au feu CS1D0 et en kraft.
L 2,97 x H 0,75 x P 0,77 m / 3,55 kg.



Bench made of high density honeycomb structured cardboard, to set up, design Grégoire Borach. Available in white, fire retardant CS1D0 and brown.
L 2,97 x H 0,75 x P 0,77 m / 3,55 kg.

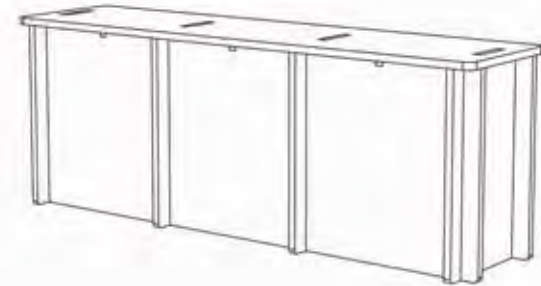

Table Vanves



Table en carton alvéolaire haute densité, livrée en kit, design Grégoire Borach.
Existe en blanc (classé au feu CS1D0) et en kraft.
L 1 x H 0,75 x l 0,77 m / 3,66 kg.

*Table made of high density honeycomb structured cardboard, to set up, design Grégoire Borach. Available in white (fire retardant CS1D0) and brown.
L1 x H 0,75 x l 0,77 m / 3,66 kg.*

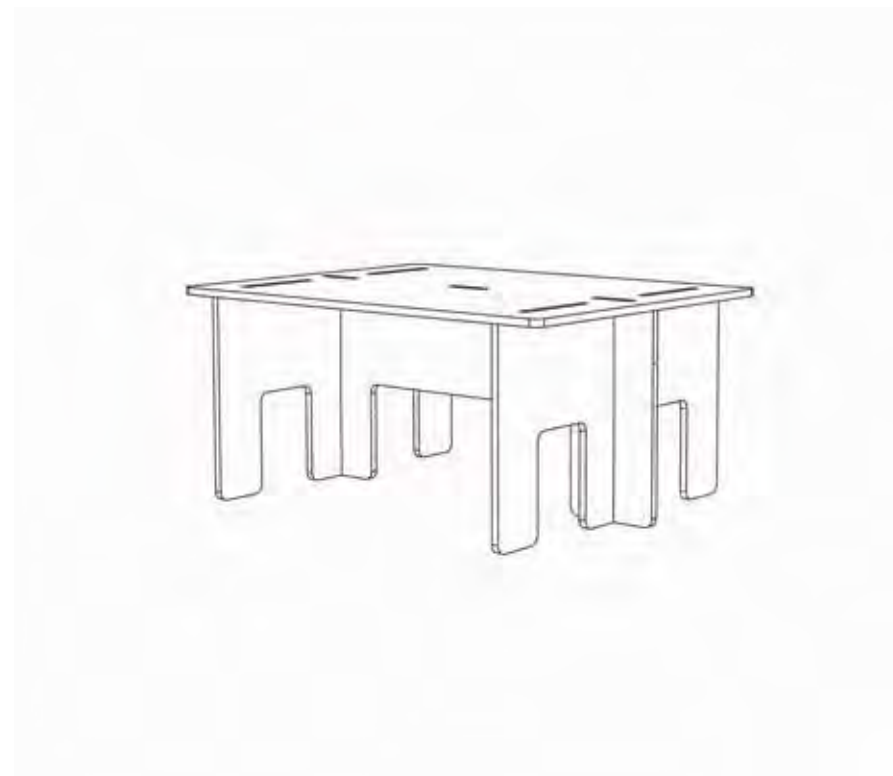

Table basse Vanves



Table basse en carton alvéolaire haute densité, livrée en kit, design Grégoire Borach. Existe en blanc (classé au feu CS1D0) et en kraft.
L1 x H 0,46 x l 0,77 m / 3,1 kg.

*Coffee table made of high density honeycomb structured cardboard, to set up, design Grégoire Borach. Available in white (fire retardant CS1D0) and brown.
L1 x H 0,46 x l 0,77 m / 3,1 kg.*



Table longue Vanves



Table en carton alvéolaire haute densité, livrée en kit, design Grégoire Borach.
Existe en blanc (classé au feu CS1D0) et en kraft.
L 2,97 x H 0,75 x l 0,77 m / 6 kg.

*Table made of high density honeycomb structured cardboard, to set up, design Grégoire Borach. Available in white (fire retardant CS1D0) and brown.
L 2,97 x H 0,75 x l 0,77 m / 6 kg.*



Console Vanves



Console en carton alvéolaire haute densité, livrée en kit, design Grégoire Borach.
Existe en blanc, classé au feu CS1D0 et en kraft.
L 1,40 x H 1,10 x P 0,36 m / 3,75 kg.

Console made of high density honeycomb structured cardboard, to set up, design Grégoire Borach. Available in white, fire retardant CS1D0 and brown.
L 1,40 x H 1,10 x P 0,36 m / 3,75 kg.



Etagère Vanves



Etagère en carton alvéolaire haute densité, livrée en kit, design Grégoire Borach.
Existe en blanc, classé au feu CS1D0 et en kraft.
L 1,28 x H 1,90 x P 0,36 m / 5,6 kg.

*Shelf made of high density honeycomb structured cardboard, to set up, design Grégoire Borach. Available in white, fire retardant CS1D0 and brown.
L 1,28 x H 1,90 x P 0,36 m / 5,6 kg.*



Portant Vanves



Portant en carton alvéolaire haute densité, livrée en kit, design Grégoire Borach.
Existe en blanc, classé au feu CS1D0 et en kraft.
L 0,75 x H 1,60 x P 0,50 m / 4,8 kg.

Hanging rail made of high density honeycomb structured cardboard, to set up, design Grégoire Borach. Available in white, fire retardant CS1D0 and brown.
L 0,75 x H 1,60 x P 0,50 m / 4,8 kg.





GOURMANDISES

Collection by Marine Peyre

DU MOBILIER GOURMAND ET RECYCLÉ !
GOURMAND AND RECYCLED FURNITURE!

100 % recyclé, 100 % made in France, innovant, compact, léger, joyeux et graphique, la collection Gourmandises donne envie d'être posée partout... On en mangerait !

100% recycled, 100% made in France, innovative, compact, light, joyful and graphic, the Gourmandises Collection makes you want to use it everywhere... Ready to be devoured!

- Pouf et banc composés de 2 parties autonomes et assemblables par emboîtement.
- Structures composées de panneaux de DropCake® découpés suivant un procédé d'encoches, permettant d'assembler sans clous ni vis. Le DropCake® est un panneau issu du recyclage de chutes de Drop Paper®.
- Coussins d'assises amovibles en mousse haute résilience recouverte par un tissu bouclette en polyester Ascot de la marque Elastron, certifié REACH et résistance à l'abrasion et aux brûlures de cigarettes.
- Disponibles en plusieurs couleurs : blanc, orange, bleu et rose.

- *Ottoman and bench made up of 2 independent parts that can be assembled by interlocking.*
- *Structures made up of DropCake® panels cut using a notch system, allowing assembly without nails or screws. DropCake® is a panel made from the recycling of Drop Paper® waste.*
- *Removable seat cushions in high resilience foam covered with an Elastron brand Ascot polyester fabric, REACH certified and resistant to abrasion and cigarette burns.*
- *Available in various colors: white, orange, blue and pink.*



CUPCAKE

ÉCLAIR AU CHOCOLAT

RELIGIEUSE

TABLE



DROP SEAT

DROP SEAT



Fauteuil «club» en PVC transparent rempli de copeaux en papier ou en carton recyclé.

Club armchair made out of transparent PVC, filled with paper or recycled cardboard strips.



STOOLY



Tabouret pliable et dépliable à l'infini, en carton et disponible 8 couleurs : 4 Stooly Classics (blanc, marron, rouge, noir) et 4 Stooly Pop (jaune, orange, bleu vert) et en 4 tailles: 28, 35, 42 ou 50 cm de haut.

Stool that can be folded and unfolded to infinity, in cardboard and available in 8 colors: 4 Stooly Classics (white, brown, red, black) and 4 Stooly Pop (yellow, orange, blue green) and in 4 sizes: 28, 35, 42 or 50 cm high.





Cardboard King Kong / Maison&Objet / Design David Mahé

ACCESSOIRES

ACCESSORIES



PAPER TREE

PAPER TREE



Arbre en PMMA alvéolaire M2 découpé
avec guirlandes de feuilles en Drop Paper M1.
Livré à plat. H 2,50 m

*Cut tree in alveolar acrylid with garlands of leaves made with Drop Paper M1. Delivered flat.
H 2,50 m*





SAPIN / FIR TREE

MOTIF CHRISTMAS / CHRISTMAS PATTERN

Structure transparente conique en 3 parties, livrée à plat et à assembler.
Base de 0,90 m de diamètre, hauteur 2,20 m. Eclairage par tube fluorescent de 2,08 m.
Recouvert de Drop Paper blanc diffusant et d'un autre Drop découpés avec tout type de pattern.



*Transparent cone structure in 3 parts, delivered flat and ready to assembly.
Base : 90 cm diam, 2,20 m high, Lighting with a fluorescent tube of 2,08 m high.
Covered with a white diffusing Drop Paper and another one on top cut with any design.*





SAPIN ÉTOILE / STAR FIR TREE

DESIGN OLIVIA MARTIN / DESIGN OLIVIA MARTIN



Sapin origami en kit à monter soi-même, autostable avec un tube fluo.
Existe en hauteur 0,80 m, 1,30 m ou 1,80 m
Standard Drop Paper® blanc 80g

*Origami fir tree, in kit form, to be put together. Stable, with a fluorescent tube.
Height 0,80 m, 1,30 m or 1,80 m*





SAPIN ÉPURE / EPURE TREE

DESIGN OLIVIA MARTIN / DESIGN OLIVIA MARTIN

Sapin origami en kit à monter soi-même, autostable avec un tube fluo.
Existe en 0,90 m de hauteur.
Drop Paper®80g ou PERFO DROP®



*Origami fir tree, in kit form, to be put together. Stable, with a fluorescent tube.
Available in 0,90 m in height.
Drop Paper®80g or PERFO DROP®*



MOMINOKI / MOMINOKI

DESIGN LIKA KATO / DESIGN LIKA KATO

Sapin origami en kit à monter soi-même, autostable avec un tube fluo.
M1

Existe en 0,80 x 1,30 m et 0,60 x 0,95 m.

Origami fir tree, in kit form, to be put together. Stable, with a fluorescent tube.

Fire retardant M1

Available in 0,80 x 1,30 m et 0,60 x 0,95 m.





LEAVES

by Normal Studio

MUR VÉGÉTAL ÉLÉGANT / ELEGANT VEGETAL WALL

- Facilité d'installation
- Léger et élégant
- Très faible volume à stocker
- Un large choix de couleurs

- Easy set up
- Light & Elegant
- Low storage volume
- A large range of colours



DROP PAPER® M1, B1
FLAME RETARDANT
DROP PAPER®



15 couleurs standards - 15 standard colors

Pour 1ml sur 5 plans

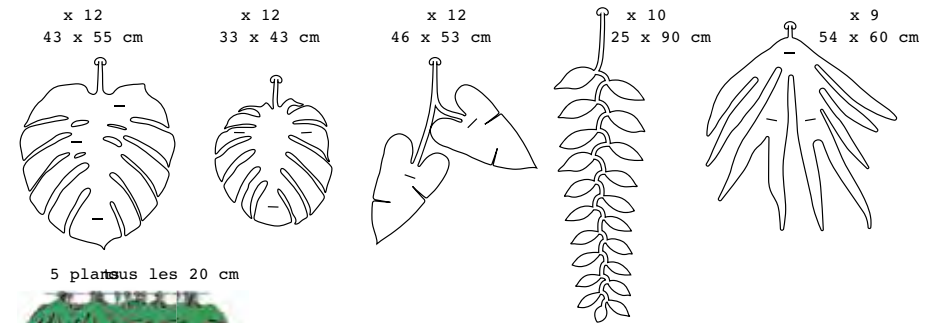

5 plants les 20 cm

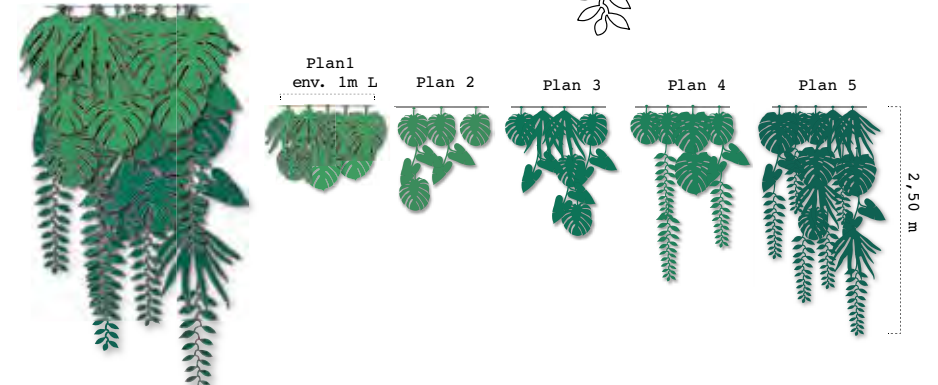



GUIRLANDE LUNAIRE MOON GARLAND

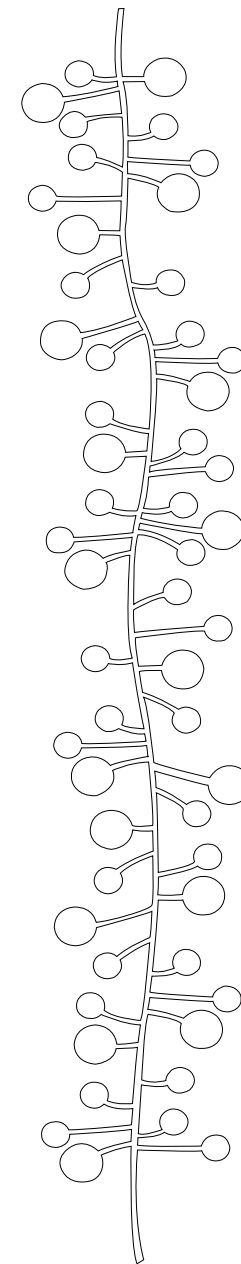
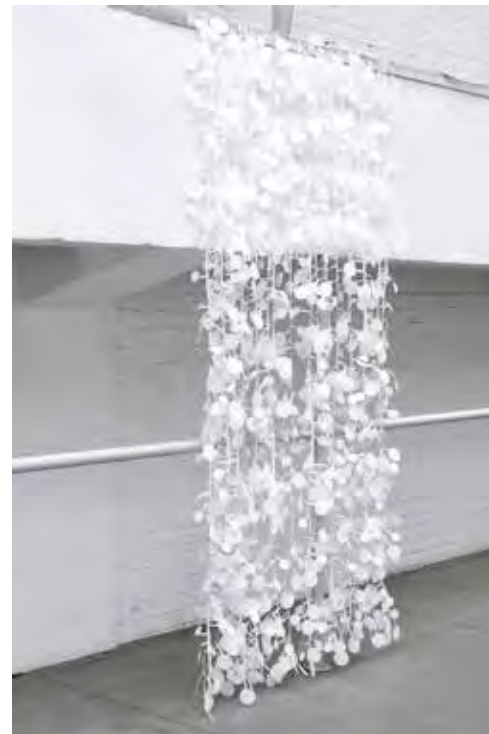



GUIRLANDE ÉRABLE MAPLE GARLAND

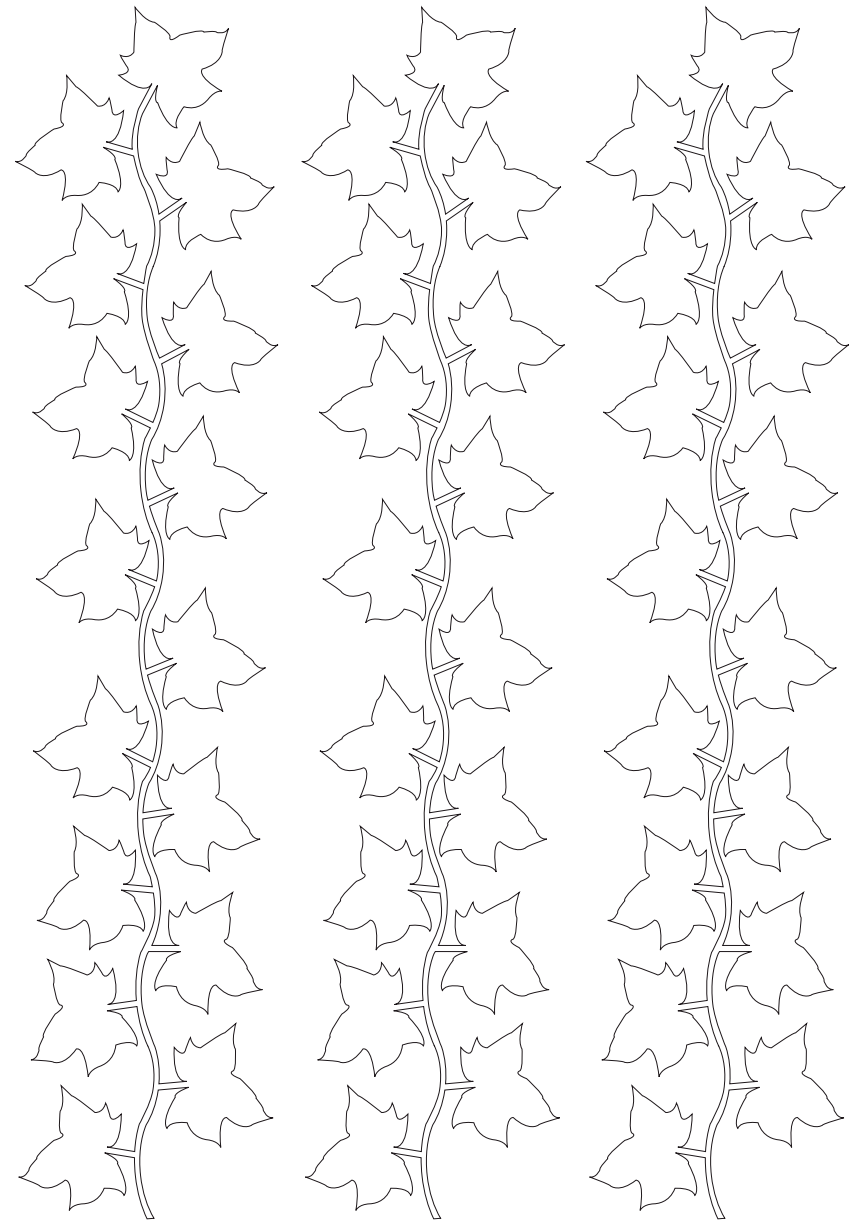



GUIRLANDE ACACIA ACACIA GARLAND

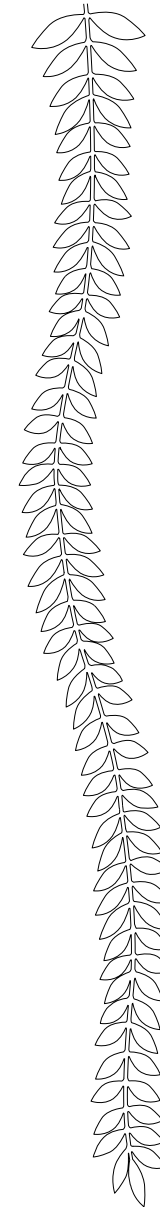
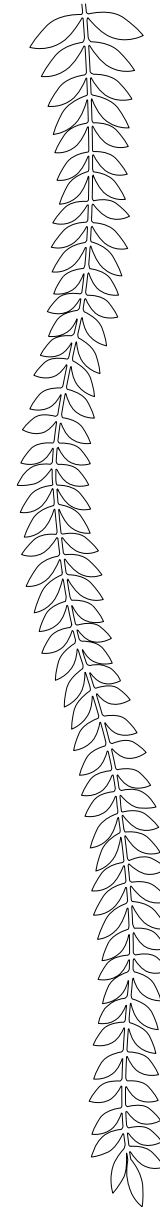
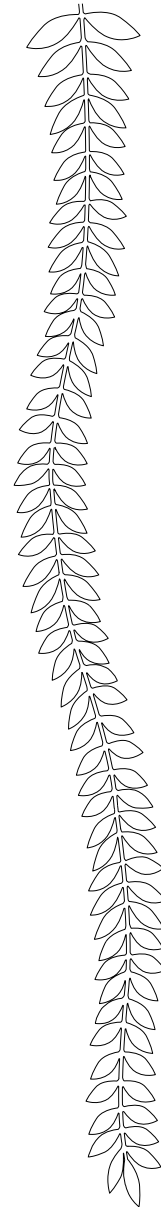



ARCH



Hauteur : 2,30 m
Longueur : 1 ml ou 2 ml (dans l'image 2ml)
Ouverture : 2,04 m
Plat acier avec tube manchonnés, peinture blanche.

*Height: 2.30m
Length: 1ml or 2ml (in the image, 2ml)
Aperture: 2.04m
Flat steel profiles, with connecting sleeves, white paint.*

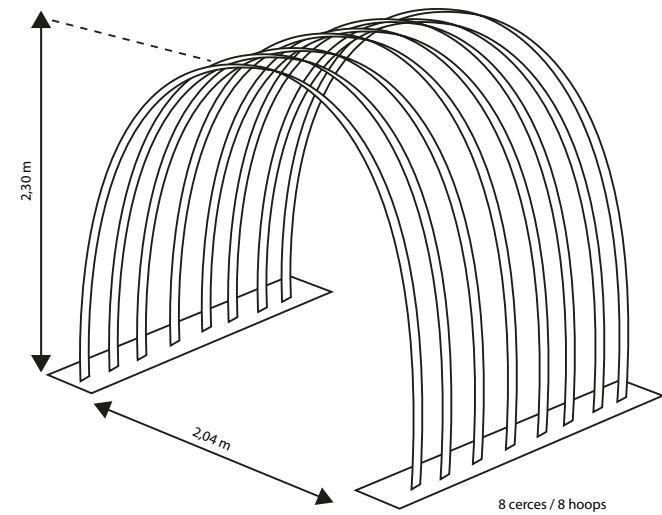



FLOWERS



Fleurs en Drop Paper sur tige 15 cm de diam.

Flower made of Drop Paper on stem, 15 cm diam.



Camélia



Élébore



Pivoine



Clématite



Dahlia



Rêve d'été

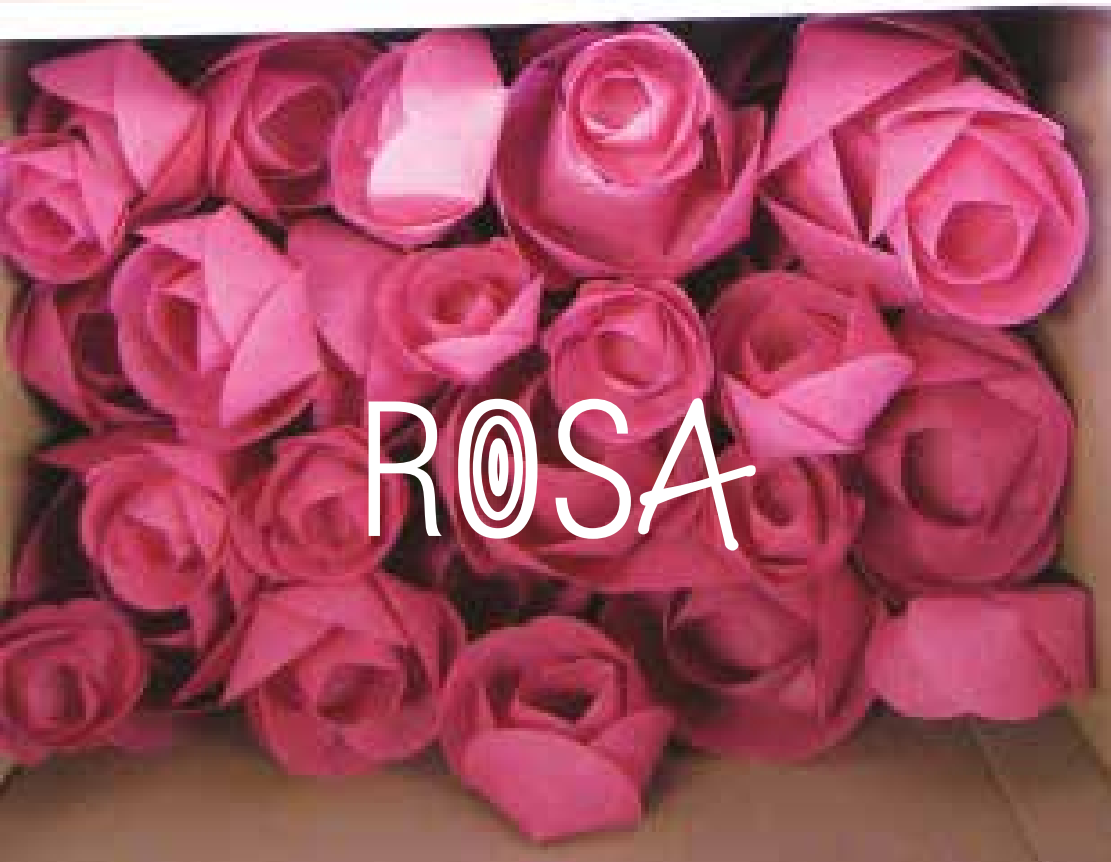

ROSA

UN EXEMPLE DE NOUVELLE VIE POUR DES CHUTES DE PAPIER !

AN EXAMPLE OF A NEW LIFE FOR PAPER WASTE!

Suite à un workshop à l'École de Design de Rennes basé sur l'utilisation de la matière contenue dans les boîtes Mystère Green de Procédés Chénel, Michelle Bonny, l'une des étudiantes, a créé Rosa, un système de fabrication de petites roses de différentes dimensions.

Ces petites roses permettent de facilement récupérer beaucoup de chutes de papier, et Procédés Chénel a décidé de lancer cette collection de fleurs prêtes à divers emplois, en en confiant la confection à des détenues.

Following a workshop led by Rennes Design School, which was focusing on using the material the Procédés Chénel's Mystère Green boxes actually contain, Michelle Bonny, one of the students, came up with this idea of manufacturing roses.

These small flowers make it easy to upcycle many paper waste, and Procédés Chénel has decided to launch a collection of these flowers, trusting prisoners with their manufacturing.



DROP PAPER® M1, B1

FLAME RETARDANT
DROP PAPER®





DROP FRUITS



Pommes et poires en nid d'abeille ou en simples écrans suspendus, à poser ou à suspendre.
Couleurs et dimensions variables.

*Apples and pears made out of honeycomb or simple suspended screens, which can either be hanged or put down.
Colors and dimensions can adaptable.*

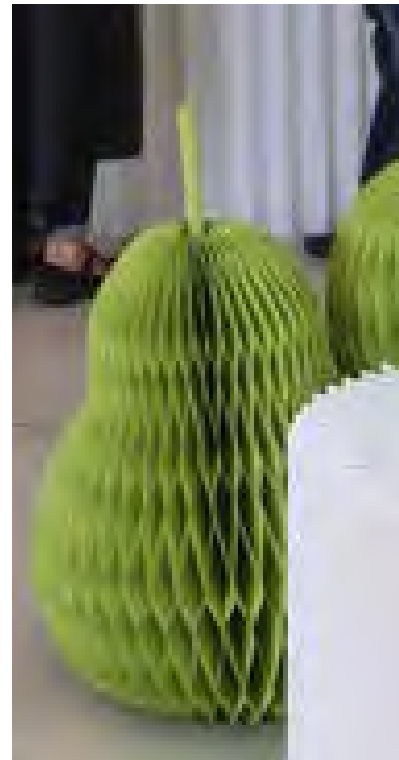

STANDING FLOWERS

Platine acier avec manchon 28 cm x 28 cm
La platine peut avoir une couleur de Drop® selon la gamme.
Tube aluminium diam. 25 mm
Hauteur de la fleur : 1 m
Envergure de la fleur + ou -35 cm



*Steel base with sleeve 28x28cm
The base can have a color from the Drop® collection
Aluminium tube diam. 25mm
Height of the flower: 1m
Wingspan of the flower approx. 35cm*





design Emmanuelle Durville

ROCKS & CLOUDS



Nuages et rochers en Drop Paper®
Dimensions et couleurs sur demande

*Rocks and clouds made out of Drop Paper®
Dimensions and colors upon request*



design Emmanuelle Durville + Maud Sarolles



JELLY FISH

design Lika Kato



Méduses en Honeycomb de Drop Paper®
Dimensions et couleurs sur demande

*Jelly fishes made out of Drop Paper® Honeycomb
Dimensions and colors upon request*



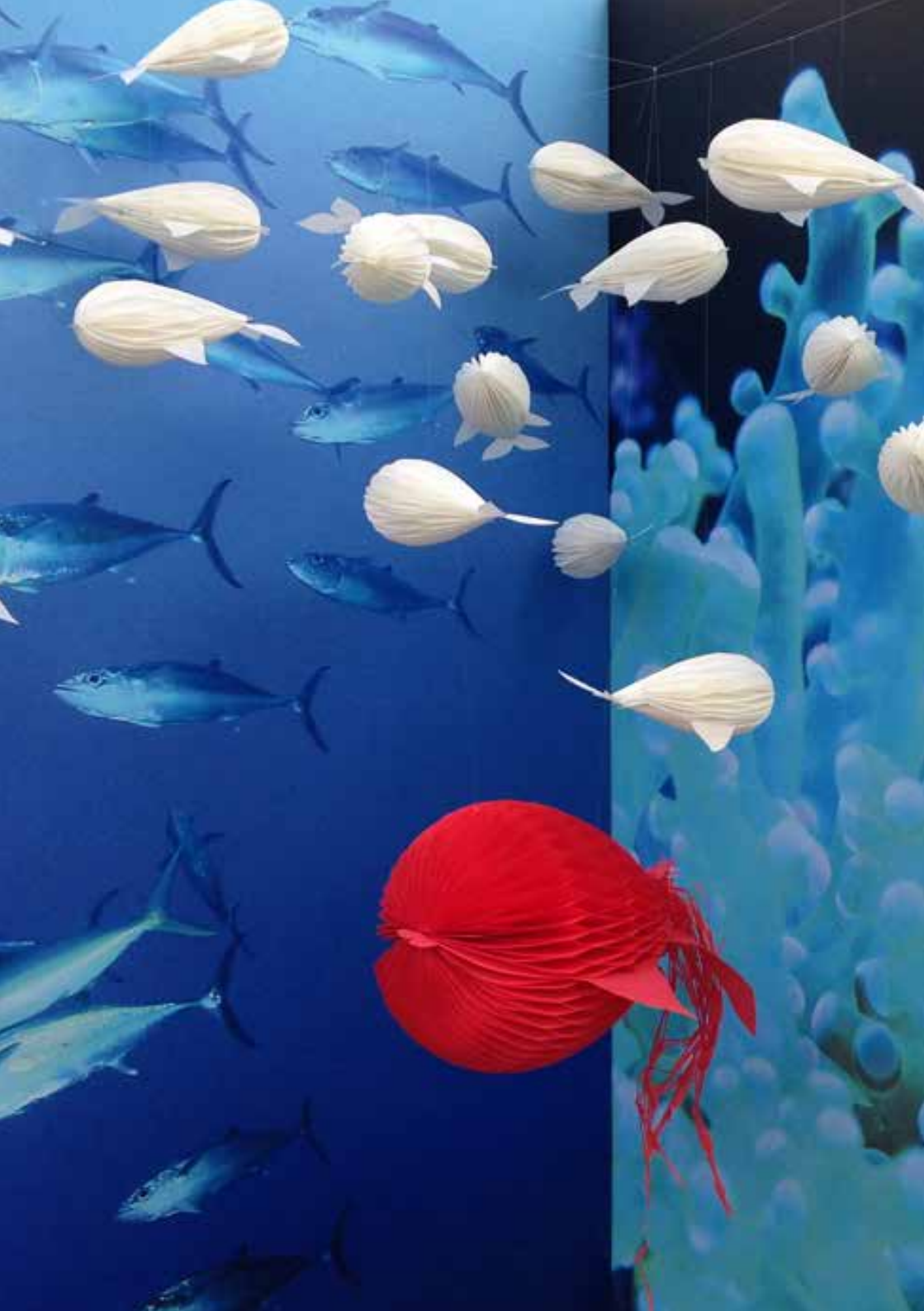

FISH

design Lika Kato



Poissons en Honeycomb de Drop Paper®
Dimensions et couleurs sur demande

*Fishes made out of Drop Paper® Honeycomb
Dimensions and colors upon request*





DOVE

design Lika Kato



Colombes en Honeycomb de Drop Paper®
Dimensions et couleurs sur demande

*Doves made out of Drop Paper® Honeycomb
Dimensions and colors upon request*



PHOTOPHORES



Photophores en Perfo Drop®
Dimensions et couleurs sur demande

*Candle holders made out of Perfo Drop®
Dimensions and colors upon request*

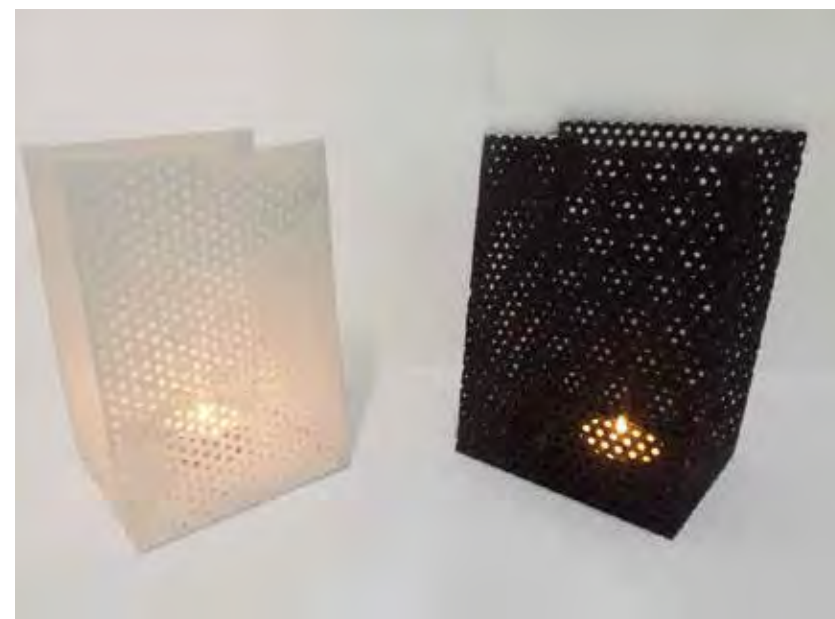



PROCÉDÉS CHÉNEL[®] INTL.
Architectures de papiers

70, rue Jean Bleuzen
92170 Vanves
France
T : +33 (0)1 41 08 76 76
F : +33 (0)1 41 08 01 53
info@chenel.com
www.chenel.com